

BACKWARDLY INCLINED CENTRIFUGAL CLASS 4 FANS



- Capacities to 170,000 CFM
- Static pressures to 20"WG
- Temperatures to 750°F.



CLASS I, II, III FANS
also available



THE NEW YORK BLOWER COMPANY
7660 Quincy Street
Willowbrook, IL 60527-5530

Visit us on the Web: <http://www.nyb.com>
Phone: (800) 208-7918 Email: nyb@nyb.com

CLASS 4 FANS

DESIGN FEATURES

- Capacities to 170,000 CFM.
- Static pressures to 20"WG.
- Temperatures to 750°F.
- Choice of direct drive or belt driven arrangements.
- Choice of AcoustaFoil® or PLR wheels.
- 15 sizes: 18" through 73" wheel diameters.
- Non-overloading horsepower characteristics ...brake horsepower levels at a point that allows economical motor selection that will not overload motor if system pressure changes.
- Specially designed diverter...improves performance efficiency and is a key factor in the stable AcoustaFoil performance.

CHOICE OF TWO WHEEL TYPES

ACOUSTAFOIL

Airfoil-blade design for the ultimate in providing efficient, quiet and stable clean-air movement.

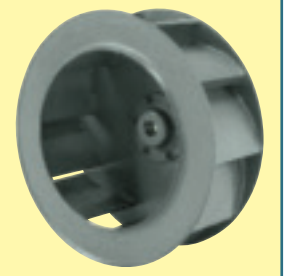

Stable performance—completely stable pressure curve from wide-open to closed-off...ideal for systems with variable performance.

Highest efficiency in working range—peak efficiency well to the right of pressure peak.

Lowest sound level—quiet range of operation corresponds to area of peak efficiency.

PLR

Flat backwardly inclined blade design for efficient air movement and minimum maintenance in contaminated air streams.

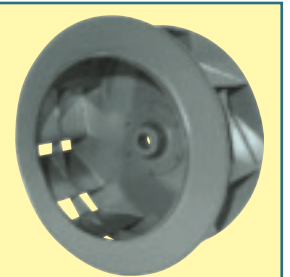

Single-thickness blades—for applications with air-borne contaminants that can be detrimental to hollow airfoil shapes.

Broad efficiency range—high-efficiency area blankets most desirable rating area of performance.

Low sound level—though not as quiet as the AcoustaFoil, lowest sound level falls in best selection area.

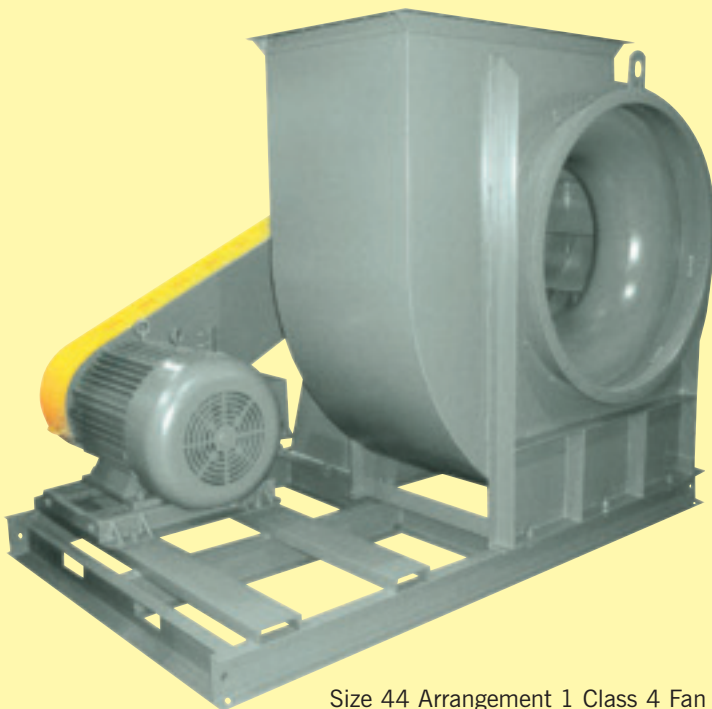

Size 44 Arrangement 1 Class 4 Fan with unitary base, motor, and belt guard.

Size 49 Arrangement 8 Class 4 Fan with coupling guard, shaft and bearing guard, motor, and gray epoxy coating.



The New York Blower Company certifies that the Class 4 Fans shown herein are licensed to bear the AMCA Seal. The ratings shown are based on tests and procedures performed in accordance with AMCA Publication 211 and comply with the requirements of the AMCA Certified Ratings Program.

ACCESSORIES

- **SHAFT SEALS**

Ceramic felt seal elements encased between metal backing plate and retaining disc...elements can be easily split for field installation and maintenance. Buna-N, Viton, and Teflon seal elements are also available.

- **INLET BOX**

Minimizes entry losses normally associated with 90° turns at or near fan inlet...also available with parallel-blade damper for efficient volume control...refer to separate Catalog Sheet.

- **SPLIT HOUSING**

See page 4 for details.

- **BOLTED CLEANOUT DOOR**

Closely spaced studs keep gasketed door securely sealed...2 inch raised bolted door also available.

- **INLET DAMPERS**

External vane construction provides pre-spun air effect to reduce fan performance efficiently...not recommended for use with inlet box...maximum temperature: 750°F.

- **FLANGES**

Outlet flange angles welded flush with fan outlet and provided with holes...inlet flange angle ring welded to inlet collar and provided with holes...companion flanges with matching hole patterns also available.

- **DRAIN**

1½ inch [npt] tank flange located at lowest point in housing scroll.

- **UNITARY BASE**

Structural steel base provides common support for fan, motor and drive components...also available with spring-type or rubber-in-shear isolators...flexible duct connections are recommended for use with isolation bases.

- **OUTLET DAMPERS**

Available in parallel or opposed blade construction...adds resistance at fan discharge to reduce flow...removable case side and linkage provide easy maintenance...see separate Catalog Sheet.

- **INSULATION STUDS**

2-inch long weld-studs located on 12-inch centers on all surfaces of housing exterior...recommended for use with field-installed insulation...studs are normally mild steel; stainless steel available on request.

- **SAFETY EQUIPMENT**

Belt guards, shaft and bearing guards, coupling guards, inlet guards, and outlet guards are available.

- **OTHER ACCESSORIES**

Also available from **nyb** are drive components such as motors, couplings, and v-belt drives as well as a variety of preventive-maintenance products including vibration detectors, bearing-temperature detectors, and zero-speed switches.

Size 18 Arrangement 1 Class 4 Fan with external inlet damper, unitary base with R-I-S isolation, shaft and bearing guard, belt guard, motor, v-belt drive, and white epoxy coating.



Size 24 Arrangement 1 Class 4 Fan with external outlet damper, unitary base, bolted cleanout door, drain, shaft and bearing guard, belt guard, motor, and v-belt drive.

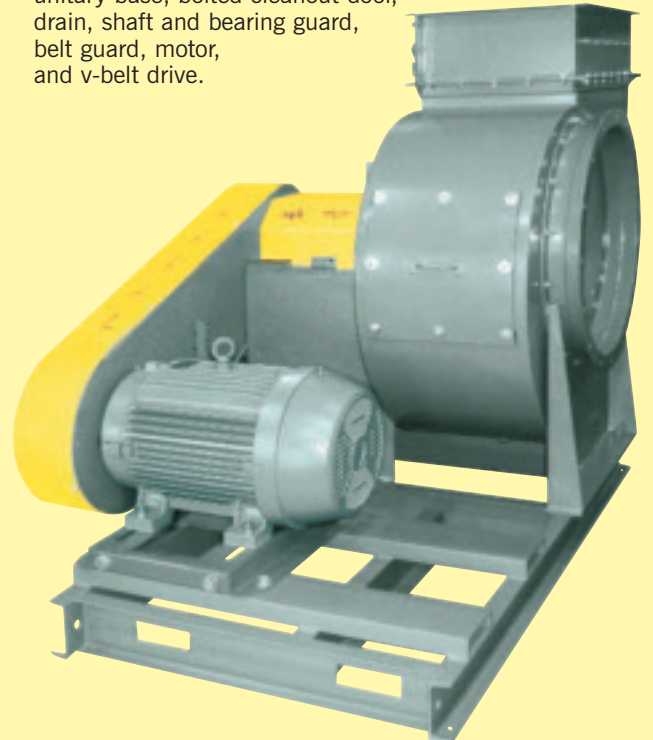

MODIFICATIONS

SPARK-RESISTANT CONSTRUCTION [SRC]

Intended to minimize the potential for any two or more fan components to generate sparks within the airstream by rubbing or striking during operation.

The following types are available:

AMCA A [AIRSTREAM] SRC

To include all airstream parts constructed of a spark-resistant alloy...maximum temperature: 200°F.

AMCA B [WHEEL] SRC

To include the fan wheel constructed of a spark-resistant alloy and a buffer plate around the housing shaft-hole opening...maximum temperature: 200°F.

AMCA C [BUFFER] SRC

To include a spark-resistant alloy buffer affixed to the housing interior adjacent to the wheel backplate, a spark-resistant alloy inlet cone, and a buffer plate around the housing shaft-hole opening...maximum temperature: 650°F.

ALL TYPES SRC

Fan is to be so constructed such that no bearings, drive components, or electrical apparatus are located in the airstream...the user must electrically ground all fan and system components.

Refer to Engineering Letter 15 for the full meaning and limits of spark-resistant construction.

HANDLING CORROSIVES

Protective coatings and special alloys are available to combat corrosion problems.

Special coatings [up to 12 mil thickness]—special paints and spray coatings are available under a variety of trade names. **nyb** works with experienced coating applicators who can apply coatings to meet a wide range of requirements.

Alternate material construction—Class 4 Fans can be constructed of aluminum or various stainless steels.

HEAT-FAN CONSTRUCTION

Arrangement 1 and 8 fans can be constructed for 750°F. maximum airstream temperature with the addition of shaft cooler and guard.

Notes:

1. High-temperature paint is furnished for airstream temperature exceeding 300°F.
2. Recessed cooler cone is furnished for shaft seal on heat fans.
3. Maximum safe wheel speeds decrease as airstream temperatures increase...see Charts I and II on page 5.

SPLIT-HOUSING CONSTRUCTION

Available with standard construction for Sizes 36-73 only [available on all sizes with HDI construction].

TYPE A

**Bottom Horizontal
Up Blast
Down Blast**

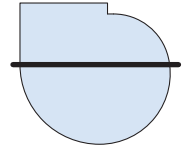

Horizontal split allows removal of top section without disturbing inlet connection...outlet connection must be broken on Up Blast fans only.

TYPE B

**Top Horizontal
Top Angular Down
Bottom Angular Up
Top Angular Up**

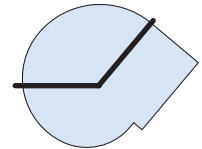

Split allows removal of pie-shaped section without disturbing inlet or outlet connections.

HDI [Heavy Duty Industrial] CONSTRUCTION

Provides channel-braced, non-rotatable housing construction on all fan sizes. Allows for the addition of split-housing construction on Sizes 18-33.

NARROW-WIDTH CONSTRUCTION

Wheel and housing widths can be adjusted to meet volume and pressure requirements at most efficient operating point.

SAFETY EQUIPMENT

Safety accessories are available from **nyb**, but selection of the appropriate devices is the responsibility of the system-designer who is familiar with the particular installation, or application, and can provide for guards for all exposed moving parts as well as protection from access to high-velocity airstreams. Neither **nyb** nor its sales representatives is in a position to make such a determination. Users and/or installers should read "Recommended Safety Practices for Air Moving Devices" as published by the Air Movement and Control Association International, Arlington Heights, Illinois.

CLASS 4 FANS

SPEED CAPABILITIES

Maximum safe operating speeds are shown in Chart I for Class 4 Fans with the standard high-strength steel wheel and the standard shaft and bearings as listed. Substitution of alternate wheel alloys, or modifications to the standard shaft and bearings selection, may alter the maximum safe speed.

Chart II provides safe speed correction factors for various temperatures and the common alternate wheel alloys. These factors apply to the wheel safe speeds listed in Chart I.

EXAMPLE: A Size 49 Fan with a 347 SST wheel operating at a maximum airstream temperature of 600°F will have a maximum safe operating speed of 1440 RPM [1600 x .90].

DENSITY CORRECTIONS

CALCULATING FANS AT TEMPERATURES OTHER THAN 70°F

When a fan handles air at 70°F, it is operating at .075 pounds per cubic foot. When a fan handles other than standard air, a density correction factor must be considered. Static pressure and brake horsepower vary inversely as the absolute temperature. For convenience, Chart III gives factors for correcting pressure and brake horsepower.

EXAMPLE:

1. Require 15,000 CFM at 12"SP at 300°F at sea level.
2. Chart III indicates a 1.43 factor for 300°F.
3. Select the fan for 17.2"SP [12" x 1.43] at 70°F.
4. Divide 70°F brake horsepower by 1.43 to determine BHP at conditions.

CALCULATING FANS AT ALTITUDES OTHER THAN SEA LEVEL [29.92 in. Hg]

If speed, capacity and temperature are kept constant, static pressure and horsepower will vary directly as the density of the air. The method for correcting the altitude is the same as for temperature except using the factors in Chart IV.

CHART I MAXIMUM SAFE SPEEDS ACOUSTAFOIL AND PLR AT 70°F.

Size	RPM	Size	RPM
18	4300	40	1945
22	3520	44	1800
24	3205	49	1600
27	2905	54	1445
30	2610	60	1305
33	2375	66	1185
36	2145	73	1075

CHART II TEMPERATURE CORRECTION FACTORS FOR WHEEL SAFE SPEEDS

Temp. °F.	Wheel and Shaft Material				
	Steel	Aluminum*	Stainless 304•	Stainless 316•	Stainless 347•
-50	1.00	1.00	1.00	1.00	1.00
70	1.00	1.00	1.00	1.00	1.00
200	.97	.98	.88	.95	.95
300	.95	—	.82	.92	.93
400	.94	—	.78	.89	.90
500	.93	—	.75	.86	.90
600	.92	—	.73	.84	.90
650	.89	—	.71	.82	.90
700	.87	—	.70	.82	.90
750	.84	—	.69	.81	.90

*Steel shaft • PLR Fans only

CHART III TEMPERATURE CORRECTIONS

Temp. °F.	Factor	Temp. °F.	Factor
-50°	.77	225°	1.29
-25°	.82	250°	1.34
0°	.87	275°	1.39
20°	.91	300°	1.43
40°	.94	325°	1.48
60°	.98	350°	1.53
70°	1.00	375°	1.58
80°	1.02	400°	1.62
100°	1.06	450°	1.72
120°	1.09	500°	1.81
140°	1.13	550°	1.91
160°	1.17	600°	2.00
180°	1.21	700°	2.19
200°	1.25	750°	2.28

NOTE: If correction factor for both temperature and altitude is required, multiply factors from Charts III and IV together: 3000' and 600°F. 1.12 x 2.00 = 2.24 [combined factor].

CHART IV ALTITUDE [ft.] CORRECTIONS

Alt.	Factor
0	1.00
500	1.02
1000	1.04
1500	1.06
2000	1.08
2500	1.10
3000	1.12
3500	1.14
4000	1.16
4500	1.18
5000	1.20
5500	1.22
6000	1.25
6500	1.27
7000	1.30
7500	1.32
8000	1.35
8500	1.37
9000	1.40
10000	1.45



ELECTRONIC CATALOG

Fan-selection program corrects for altitude, temperature, rarefaction, adjusts maximum safe speed for wheel width, and generates performance curves. Also includes complete product literature, guide specifications, installation and maintenance literature, Engineering Letters, web-site launch, and a listing of New York Blower sales representatives.

USING CAPACITY TABLES

The capacities shown in the tables on pages 6–11 are based on belt-drive selections. For a required performance, the tables provide a means of determining fan size, outlet velocity, speed and brake horsepower. For capacities for direct-drive fan performance, use **nyb** Electronic Catalog software [see description above]. To obtain a copy, contact your New York Blower sales representative or **nyb** at www.nyb.com.

1. Ratings are based on standard 70°F. air at a density of .075 pounds per cubic foot. See page 5 for density correction factors.
2. Performance shown is for Class 4 belt-drive fans with outlet ducts and without inlet ducts.
3. For a given selection, check the required fan speed at the maximum operating temperature against the maximum safe speeds shown in Chart I on page 5.

SIZE 18		AcustaFoil				Wheel diameter: 18.25" Wheel circumference: 4.77'				Capacity outlet area: 1.92 ft. ²				Maximum BHP = 0.42 $\left[\frac{\text{RPM}}{1000}\right]^3$							
CFM	OV	11"SP		12"SP		13"SP		14"SP		15"SP		16"SP		17"SP		18"SP		19"SP		20"SP	
		RPM	BHP	RPM	BHP	RPM	BHP	RPM	BHP	RPM	BHP	RPM	BHP	RPM	BHP	RPM	BHP	RPM	BHP	RPM	BHP
4000	2083	3072	10.5	3211	11.8	3336	13.0	3457	14.2	3587	15.6	3711	17.0	3811	18.1	3933	19.6	4045	21.0	4163	22.6
4500	2344	3106	11.4	3226	12.6	3345	13.8	3473	15.2	3586	16.5	3706	17.9	3819	19.3	3924	20.7	4035	22.2	4136	23.6
5000	2604	3146	12.2	3271	13.5	3386	14.8	3489	16.1	3609	17.5	3714	18.9	3826	20.4	3930	21.8	4026	23.2	4142	24.9
5500	2865	3214	13.2	3328	14.6	3432	15.9	3543	17.3	3641	18.6	3745	20.0	3854	21.6	3947	23.0	4056	24.7	4146	26.1
6000	3125	3296	14.4	3402	15.8	3497	17.0	3599	18.5	3706	20.0	3800	21.4	3899	23.0	3993	24.5	4092	26.1	4184	27.7
6500	3385	3385	15.6	3475	16.9	3579	18.4	3672	19.8	3771	21.4	3857	22.8	3948	24.3	4042	25.9	4142	27.7	4225	29.2
7000	3646	3484	17.0	3576	18.4	3666	19.9	3761	21.4	3845	22.9	3933	24.4	4016	25.9	4103	27.5	4194	29.2	4289	31.1
7500	3906	3587	18.5	3674	19.9	3766	21.5	3848	23.0	3933	24.5	4022	26.2	4100	27.7	4181	29.3	4265	31.1		
8000	4167	3700	20.1	3783	21.6	3869	23.2	3946	24.7	4026	26.3	4110	28.0	4197	29.8	4273	31.4				

SIZE 22		AcustaFoil				Wheel diameter: 22.25" Wheel circumference: 5.82'				Capacity outlet area: 2.85 ft. ²				Maximum BHP = 1.14 $\left[\frac{\text{RPM}}{1000}\right]^3$							
CFM	OV	11"SP		12"SP		13"SP		14"SP		15"SP		16"SP		17"SP		18"SP		19"SP		20"SP	
		RPM	BHP	RPM	BHP	RPM	BHP	RPM	BHP	RPM	BHP	RPM	BHP	RPM	BHP	RPM	BHP	RPM	BHP	RPM	BHP
6000	2105	2530	15.7	2638	17.5	2744	19.3	2847	21.2	2945	23.1	3037	25.0	3135	27.0	3224	29.0	3317	31.2	3400	33.2
6700	2351	2554	16.9	2658	18.7	2751	20.5	2852	22.4	2948	24.4	3040	26.4	3138	28.6	3228	30.7	3310	32.7	3396	34.9
7400	2596	2589	18.2	2691	20.1	2784	22.0	2874	23.9	2970	26.0	3062	28.1	3149	30.2	3241	32.5	3313	34.4	3402	36.8
8100	2842	2640	19.7	2726	21.5	2819	23.5	2909	25.5	2996	27.6	3079	29.6	3167	31.9	3249	34.1	3336	36.4	3416	38.7
8800	3088	2697	21.2	2778	23.1	2863	25.1	2954	27.3	3034	29.4	3119	31.6	3199	33.8	3284	36.2	3363	38.5	3435	40.7
9500	3333	2760	22.9	2842	24.9	2922	27.0	3007	29.2	3082	31.3	3160	33.5	3243	36.0	3312	38.1	3393	40.6	3469	43.0
10200	3579	2833	24.7	2911	26.9	2994	29.2	3060	31.1	3145	33.6	3218	35.9	3295	38.3	3360	40.4	3435	42.9	3505	45.3
10900	3825	2911	26.7	2991	29.1	3064	31.3	3134	33.5	3206	35.8	3276	38.1	3348	40.6	3416	43.0	3487	45.5		
11600	4070	2997	29.0	3069	31.3	3139	33.6	3205	35.8	3281	38.4	3347	40.8	3416	43.3	3480	45.7				

SIZE 24		AcustaFoil				Wheel diameter: 24.5" Wheel circumference: 6.40'				Capacity outlet area: 3.45 ft. ²				Maximum BHP = 1.70 $\left[\frac{\text{RPM}}{1000}\right]^3$							
CFM	OV	11"SP		12"SP		13"SP		14"SP		15"SP		16"SP		17"SP		18"SP		19"SP		20"SP	
		RPM	BHP	RPM	BHP	RPM	BHP	RPM	BHP	RPM	BHP	RPM	BHP	RPM	BHP	RPM	BHP	RPM	BHP	RPM	BHP
8400	2435	2358	19.6	2451	21.6	2551	23.8	2642	26.0	2729	28.2	2822	30.6	2910	33.0	2992	35.4	3078	38.0	3156	40.4
9100	2638	2380	20.8	2473	22.9	2565	25.1	2648	27.2	2736	29.5	2830	32.1	2909	34.4	2994	37.0	3072	39.4	3154	42.1
9800	2841	2411	22.1	2497	24.2	2582	26.4	2674	28.9	2755	31.2	2841	33.7	2914	35.9	2991	38.3	3073	41.0	3158	43.9
10500	3043	2448	23.4	2536	25.8	2616	28.1	2694	30.3	2777	32.8	2857	35.3	2933	37.7	3013	40.4	3088	43.0	3167	45.7
11200	3246	2491	24.9	2574	27.3	2650	29.6	2730	32.1	2801	34.4	2875	36.8	2954	39.5	3028	42.1	3106	45.0	3179	47.7
11900	3449	2545	26.6	2624	29.2	2697	31.5	2766	33.9	2840	36.4	2910	38.9	2984	41.6	3054	44.2	3127	47.0	3195	49.6
12600	3652	2603	28.5	2674	30.9	2743	33.3	2816	36.0	2879	38.3	2946	40.8	3016	43.5	3089	46.4	3150	48.9		
13300	3855	2665	30.4	2733	32.9	2800	35.5	2864	38.0	2931	40.6	2995	43.2	3062	46.0	3125	48.7	3190	51.5		
14000	4058	2730	32.5	2792	34.9	2857	37.6	2918	40.1	2983	42.9	3044	45.6	3108	48.4	3174	51.4				

Performance certified is for installation Type B: Free inlet, Ducted outlet. Power rating [BHP] does not include transmission losses. Performance ratings do not include the effects of appurtenances [accessories].

SIZE 27		AcustaFoil		Wheel diameter: 27.0" Wheel circumference: 7.06'				Capacity outlet area: 4.19 ft. ²				Maximum BHP = 3.00 $\left[\frac{\text{RPM}}{1000}\right]^3$									
CFM	OV	11"SP		12"SP		13"SP		14"SP		15"SP		16"SP		17"SP		18"SP		19"SP		20"SP	
		RPM	BHP	RPM	BHP	RPM	BHP	RPM	BHP	RPM	BHP	RPM	BHP	RPM	BHP	RPM	BHP	RPM	BHP	RPM	BHP
11000	2625	2121	24.3	2213	26.9	2297	29.5	2388	32.4	2468	35.1	2544	37.8	2625	40.8	2711	44.1	2779	46.9	2851	49.9
12000	2864	2144	26.1	2228	28.7	2312	31.5	2387	34.0	2467	36.9	2552	40.0	2625	42.9	2702	46.0	2783	49.4	2848	52.3
13000	3103	2169	27.9	2252	30.7	2330	33.5	2405	36.2	2486	39.3	2564	42.4	2630	45.1	2709	48.5	2774	51.3	2851	54.9
14000	3341	2211	30.1	2278	32.6	2356	35.6	2426	38.4	2507	41.7	2580	44.8	2640	47.4	2721	51.0	2788	54.2	2860	57.6
15000	3580	2252	32.3	2321	35.1	2395	38.2	2461	41.0	2531	44.1	2598	47.1	2669	50.5	2736	53.7	2806	57.2	2872	60.5
16000	3819	2302	34.8	2364	37.5	2434	40.7	2496	43.6	2568	47.0	2631	50.1	2698	53.4	2753	56.3	2826	60.1	2887	63.4
17000	4057	2357	37.4	2421	40.5	2483	43.5	2543	46.6	2605	49.8	2665	53.0	2728	56.3	2794	60.0	2848	63.1		
18000	4296	2419	40.3	2477	43.3	2537	46.6	2594	49.7	2654	53.1	2712	56.4	2771	59.9	2828	63.2	2886	66.7		
19000	4535	2485	43.5	2541	46.7	2594	49.8	2650	53.1	2703	56.3	2758	59.7	2815	63.3	2874	67.1				

SIZE 30		AcustaFoil		Wheel diameter: 30.0" Wheel circumference: 7.85'				Capacity outlet area: 5.17 ft. ²				Maximum BHP = 5.07 $\left[\frac{\text{RPM}}{1000}\right]^3$									
CFM	OV	11"SP		12"SP		13"SP		14"SP		15"SP		16"SP		17"SP		18"SP		19"SP		20"SP	
		RPM	BHP	RPM	BHP	RPM	BHP	RPM	BHP	RPM	BHP	RPM	BHP	RPM	BHP	RPM	BHP	RPM	BHP	RPM	BHP
14000	2708	1923	31.2	1999	34.3	2082	37.9	2156	41.2	2227	44.6	2304	48.4	2376	52.2	2443	55.9	2514	59.9	2578	63.7
15200	2940	1936	33.0	2012	36.4	2087	39.9	2161	43.4	2234	47.1	2303	50.7	2376	54.8	2446	58.7	2510	62.6	2578	66.7
16400	3172	1962	35.2	2038	38.9	2108	42.4	2170	45.6	2243	49.6	2307	53.1	2381	57.4	2445	61.3	2512	65.4	2573	69.4
17600	3404	1997	37.8	2058	41.0	2130	44.9	2194	48.5	2255	52.0	2320	55.9	2390	60.2	2448	63.9	2517	68.4	2574	72.2
18800	3636	2036	40.5	2100	44.2	2163	47.8	2223	51.5	2287	55.5	2349	59.4	2407	63.3	2469	67.4	2526	71.4	2586	75.7
20000	3868	2080	43.4	2141	47.2	2201	51.0	2253	54.4	2314	58.5	2372	62.5	2427	66.3	2490	70.9	2544	74.9	2600	79.2
21200	4101	2130	46.6	2185	50.3	2238	54.0	2298	58.2	2351	62.1	2407	66.2	2465	70.6	2513	74.3	2570	78.9		
22400	4333	2184	50.1	2238	54.0	2289	57.9	2343	62.0	2394	65.9	2447	70.2	2497	74.3	2549	78.6	2597	82.7		
23600	4565	2241	53.8	2289	57.6	2339	61.6	2386	65.5	2436	69.7	2487	74.1	2540	78.7	2585	82.7				

SIZE 33		AcustaFoil		Wheel diameter: 33.0" Wheel circumference: 8.63'				Capacity outlet area: 6.26 ft. ²				Maximum BHP = 8.35 $\left[\frac{\text{RPM}}{1000}\right]^3$									
CFM	OV	11"SP		12"SP		13"SP		14"SP		15"SP		16"SP		17"SP		18"SP		19"SP		20"SP	
		RPM	BHP	RPM	BHP	RPM	BHP	RPM	BHP	RPM	BHP	RPM	BHP	RPM	BHP	RPM	BHP	RPM	BHP	RPM	BHP
16000	2556	1727	36.7	1798	40.5	1868	44.6	1929	48.4	1994	52.8	2056	57.1	2114	61.4	2175	66.1	2230	70.6	2288	75.4
17600	2812	1727	39.0	1801	43.1	1875	47.4	1943	51.6	2009	56.1	2065	60.1	2124	64.6	2187	69.7	2236	73.8	2297	79.2
19200	3067	1741	41.6	1808	45.8	1875	50.1	1947	54.8	2019	59.6	2083	64.2	2137	68.4	2194	73.0	2254	78.2	2310	83.2
20800	3323	1782	45.0	1836	49.1	1893	53.4	1949	57.6	2014	62.4	2078	67.2	2139	72.0	2204	77.3	2266	82.6	2317	87.2
22400	3578	1838	49.2	1882	52.9	1927	56.9	1980	61.6	2031	66.0	2089	71.1	2146	75.9	2205	81.1	2268	86.7	2321	91.5
24000	3834	1896	53.5	1939	57.5	1983	61.8	2025	65.9	2073	70.8	2118	75.4	2166	80.2	2216	85.2	2268	90.3	2329	96.4
25600	4089	1956	58.2	2002	62.8	2041	66.9	2081	71.3	2124	76.0	2168	80.9	2208	85.6	2250	90.4	2294	95.5	2340	101
27200	4345	2018	63.3	2063	68.1	2101	72.4	2146	77.5	2182	81.9	2220	86.6	2259	91.5	2300	96.7	2337	101	2375	106
28800	4601	2083	68.9	2123	73.5	2164	78.4	2203	83.2	2244	88.3	2281	93.2	2319	98.4	2354	103				

SIZE 36		AcustaFoil		Wheel diameter: 36.5" Wheel circumference: 9.55'				Capacity outlet area: 7.66 ft. ²				Maximum BHP = 13.2 $\left[\frac{\text{RPM}}{1000}\right]^3$									
CFM	OV	11"SP		12"SP		13"SP		14"SP		15"SP		16"SP		17"SP		18"SP		19"SP		20"SP	
		RPM	BHP	RPM	BHP	RPM	BHP	RPM	BHP	RPM	BHP	RPM	BHP	RPM	BHP	RPM	BHP	RPM	BHP	RPM	BHP
19000	2480	1574	42.5	1634	46.6	1706	51.7	1769	56.4	1830	61.2	1887	65.9	1947	71.1	2002	76.0	2060	81.4	2121	87.4
21000	2742	1580	45.4	1646	50.2	1710	55.1	1774	60.2	1828	64.8	1886	69.8	1947	75.4	2004	80.8	2056	85.9	2110	91.5
23000	3003	1599	48.8	1659	53.6	1718	58.5	1781	64.0	1836	69.0	1895	74.5	1951	79.9	2002	85.1	2057	90.8	2114	97.0
25000	3264	1622	52.4	1678	57.2	1738	62.7	1791	67.6	1847	73.1	1907	79.2	1958	84.5	2011	90.3	2068	96.6	2113	102
27000	3525	1654	56.4	1711	61.9	1762	67.0	1812	72.1	1865	77.6	1920	83.7	1967	88.9	2023	95.4	2068	101	2123	107
29000	3786	1696	61.3	1743	66.2	1796	72.0	1843	77.3	1893	83.0	1945	89.2	1989	94.6	2042	101	2084	106	2135	113
31000	4047	1737	65.9	1786	71.6	1833	77.2	1878	82.8	1926	88.7	1971	94.4	2017	101	2067	107	2112	114		
33000	4308	1788	71.7	1832	77.2	1873	82.7	1921	89.1	1963	94.7	2005	101	2050	107	2092	113	2135	119		
35000	4569	1837	77.2	1880	83.2	1921	88.9	1963	95.1	2003	101	2044	107	2087	114	2127	120				

SIZE 40		AcustaFoil		Wheel diameter: 40.25" Wheel circumference: 10.5'				Capacity outlet area: 9.31 ft. ²				Maximum BHP = 21.5 $\left[\frac{\text{RPM}}{1000}\right]^3$									
CFM	OV	11"SP		12"SP		13"SP		14"SP		15"SP		16"SP		17"SP		18"SP		19"SP		20"SP	
		RPM	BHP	RPM	BHP	RPM	BHP	RPM	BHP	RPM	BHP	RPM	BHP	RPM	BHP	RPM	BHP	RPM	BHP	RPM	BHP
23000	2470	1427	51.6	1482	56.6	1542	62.3	1600	68.2	1663	74.9	1715	80.8	1771	87.3	1822	93.5	1875	100	1923	107
25500	2739	1433	55.0	1493	60.9	1547	66.5	1604	72.7	1660	79.1	1713	85.4	1762	91.5	1815	98.2	1870	106	1920	113
28000	3008	1450	59.1	1504	65.0	1558	71.1	1616	77.9	1667	84.1	1721	90.9	1772	97.7	1819	104	1869	111	1914	118
30500	3276	1475	63.9	1526	69.9	1576	76.0	1629	82.8	1676	88.9	1725	95.7	1777	103	1820	109	1872	117	1920	125
33000	3545	1506	69.3	1555	75.6	1598	81.3	1648	88.2	1696	95.0	1742	102	1790	109	1836	116	1877	123	1927	131
35500	3813	1541	74.8	1583	80.8	1632	88.0	1675	94.5	1721	102	1764	108	1810	116	1852	123	1896	131	1937	138
38000	4082	1581	81.0	1625	88.0	1665	94.3	1706	101	1750	108	1791	115	1834	123	1874	130	1916	138		
40500	4350	1626	88.0	1666	94.8	1704	102	1744	109	1786	116	1821	123	1863	131	1906	139	1940	146		
43000	4619	1673	95.3	1713	103	1750	110	1785	117	1822	124	1860	132	1900	140	1936	148				

Performance certified is for installation Type B: Free inlet, Ducted outlet. Power rating [BHP] does not include transmission losses. Performance ratings do not include the effects of appurtenances [accessories].

SIZE 44		AcoustaFoil		Wheel diameter: 44.5" Wheel circumference: 11.6'				Capacity outlet area: 11.4 ft. ²				Maximum BHP = 35.6 $\left[\frac{\text{RPM}}{1000}\right]^3$									
CFM	OV	11"SP		12"SP		13"SP		14"SP		15"SP		16"SP		17"SP		18"SP		19"SP		20"SP	
		RPM	BHP	RPM	BHP	RPM	BHP	RPM	BHP	RPM	BHP	RPM	BHP	RPM	BHP	RPM	BHP	RPM	BHP	RPM	BHP
32000	2809	1297	68.3	1351	75.5	1404	83.1	1450	90.1	1506	98.7	1553	107	1597	114	1644	122	1686	130	1731	139
35000	3073	1315	73.5	1364	80.8	1413	88.4	1460	96.0	1511	104	1554	112	1600	120	1648	129	1686	137	1733	146
38000	3336	1339	79.5	1386	87.1	1431	94.7	1476	102	1518	110	1567	119	1609	128	1654	136	1695	145	1738	154
41000	3600	1366	85.7	1411	93.5	1454	101	1495	109	1539	118	1581	126	1620	135	1661	143	1704	153	1744	162
44000	3863	1399	92.6	1441	101	1479	108	1518	117	1560	125	1599	134	1641	143	1680	152	1720	162	1757	171
47000	4126	1436	100	1474	109	1514	117	1552	126	1588	134	1626	143	1661	152	1698	161	1736	170	1776	181
50000	4390	1479	109	1513	117	1548	126	1585	135	1620	143	1656	153	1690	162	1725	171	1762	181	1795	190
53000	4653	1520	118	1553	126	1588	135	1620	144	1654	153	1689	163	1722	172	1752	181	1787	191		
56000	4917	1566	128	1599	137	1630	146	1662	155	1691	164	1725	174	1757	184	1786	193				

SIZE 49		AcoustaFoil		Wheel diameter: 49.0" Wheel circumference: 12.8'				Capacity outlet area: 13.8 ft. ²				Maximum BHP = 57.6 $\left[\frac{\text{RPM}}{1000}\right]^3$									
CFM	OV	11"SP		12"SP		13"SP		14"SP		15"SP		16"SP		17"SP		18"SP		19"SP		20"SP	
		RPM	BHP	RPM	BHP	RPM	BHP	RPM	BHP	RPM	BHP	RPM	BHP	RPM	BHP	RPM	BHP	RPM	BHP	RPM	BHP
35000	2536	1170	77.1	1220	85.4	1269	94.1	1316	103	1362	112	1410	122	1449	130	1498	141	1534	149	1580	161
38600	2797	1177	82.4	1226	91.3	1275	101	1318	109	1364	119	1408	128	1449	137	1492	148	1538	159	1572	168
42200	3058	1196	89.3	1238	97.5	1283	107	1327	116	1369	126	1414	136	1456	146	1495	156	1537	167	1574	177
45800	3319	1214	95.7	1257	105	1299	114	1340	124	1379	133	1420	143	1459	154	1500	164	1538	175	1578	186
49400	3580	1238	103	1278	113	1318	122	1357	132	1394	141	1432	152	1473	163	1511	174	1547	184	1583	196
53000	3841	1270	112	1306	121	1341	131	1377	141	1416	151	1448	161	1487	172	1523	183	1556	194	1595	206
56600	4101	1300	120	1335	130	1372	141	1404	151	1437	161	1472	172	1509	183	1543	195	1575	205		
60200	4362	1338	131	1370	141	1402	151	1437	162	1465	172	1499	183	1531	194	1563	206	1593	216		
63800	4623	1375	141	1406	152	1438	163	1468	173	1500	185	1529	196	1559	207	1591	219				

SIZE 54		AcoustaFoil		Wheel diameter: 54.25" Wheel circumference: 14.2'				Capacity outlet area: 16.9 ft. ²				Maximum BHP = 95.8 $\left[\frac{\text{RPM}}{1000}\right]^3$									
CFM	OV	11"SP		12"SP		13"SP		14"SP		15"SP		16"SP		17"SP		18"SP		19"SP		20"SP	
		RPM	BHP	RPM	BHP	RPM	BHP	RPM	BHP	RPM	BHP	RPM	BHP	RPM	BHP	RPM	BHP	RPM	BHP	RPM	BHP
47000	2778	1064	101	1106	111	1151	123	1190	133	1233	145	1273	157	1310	168	1350	181	1386	193	1424	206
51000	3014	1077	108	1116	118	1157	130	1198	141	1237	153	1274	165	1313	177	1350	189	1383	201	1423	216
55000	3251	1093	115	1129	126	1168	137	1206	149	1242	161	1281	173	1317	186	1356	200	1386	211	1423	225
59000	3487	1110	123	1145	134	1186	147	1222	159	1256	171	1292	183	1326	196	1362	210	1391	221	1430	237
63000	3723	1133	132	1170	144	1202	156	1236	168	1269	180	1303	193	1336	206	1369	219	1405	234	1433	246
67000	3960	1160	142	1193	154	1224	166	1258	179	1285	190	1318	203	1353	218	1385	232	1415	245		
71000	4196	1186	152	1218	165	1249	177	1278	189	1308	202	1340	216	1369	229	1400	244	1428	257		
75000	4433	1217	164	1245	176	1275	189	1304	202	1333	216	1361	228	1389	242	1419	257				
79000	4669	1249	176	1277	189	1304	202	1332	215	1361	230	1387	243	1415	258	1441	271				

SIZE 60		AcoustaFoil		Wheel diameter: 60.0" Wheel circumference: 15.7'				Capacity outlet area: 20.7 ft. ²				Maximum BHP = 158 $\left[\frac{\text{RPM}}{1000}\right]^3$									
CFM	OV	11"SP		12"SP		13"SP		14"SP		15"SP		16"SP		17"SP		18"SP		19"SP		20"SP	
		RPM	BHP	RPM	BHP	RPM	BHP	RPM	BHP	RPM	BHP	RPM	BHP	RPM	BHP	RPM	BHP	RPM	BHP	RPM	BHP
57000	2754	962	123	1001	135	1038	148	1079	163	1114	176	1151	191	1185	205	1222	221	1255	236	1284	249
62000	2995	972	131	1008	144	1046	158	1080	171	1120	187	1154	201	1185	215	1219	230	1254	247	1286	262
67000	3237	985	140	1021	154	1054	167	1089	181	1126	197	1157	211	1191	227	1222	242	1254	258	1284	273
72000	3478	1005	151	1037	164	1071	179	1101	192	1132	207	1166	223	1197	238	1230	255	1260	271	1292	288
77000	3720	1024	161	1055	175	1088	191	1116	204	1146	219	1177	235	1211	253	1238	268	1266	284	1296	301
82000	3961	1047	173	1077	188	1106	203	1133	217	1165	234	1192	249	1220	265	1250	282	1281	300		
87000	4203	1075	187	1101	202	1130	217	1156	232	1184	248	1210	264	1237	280	1265	297	1295	316		
92000	4444	1103	202	1127	216	1155	232	1181	248	1208	265	1233	281	1259	298	1283	314				
97000	4686	1131	216	1157	233	1181	249	1207	265	1231	281	1255	298	1281	316	1304	333				

SIZE 66		AcoustaFoil		Wheel diameter: 66.0" Wheel circumference: 17.3'				Capacity outlet area: 25.0 ft. ²				Maximum BHP = 255 $\left[\frac{\text{RPM}}{1000}\right]^3$									
CFM	OV	11"SP		12"SP		13"SP		14"SP		15"SP		16"SP		17"SP		18"SP		19"SP		20"SP	
		RPM	BHP	RPM	BHP	RPM	BHP	RPM	BHP	RPM	BHP	RPM	BHP	RPM	BHP	RPM	BHP	RPM	BHP	RPM	BHP
76000	3038	887	161	920	177	951	192	985	210	1018	228	1048	245	1081	264	1107	280	1139	300	1168	319
81000	3237	896	169	929	187	959	203	991	220	1022	238	1051	255	1082	274	1110	292	1140	312	1171	333
86000	3437	909	180	939	196	970	214	1001	232	1027	247	1058	267	1087	286	1117	306	1146	326	1171	344
91000	3637	924	191	953	207	981	224	1010	242	1038	260	1068	280	1095	299	1124	320	1147	336	1179	360
96000	3837	941	202	969	220	996	237	1025	256	1049	273	1077	293	1104	312	1131	333	1157	352	1184	373
101000	4037	960	215	985	232	1011	250	1039	270	1062	287	1089	307	1115	327	1138	345	1166	368		
106000	4237	980	229	1004	246	1030	266	1055	284	1080	304	1104	323	1129	343	1152	362	1175	382		
111000	4436	1002	243	1023	260	1049	281	1070	298	1095	318	1118	338	1143	359	1165	378				
116000	4636	1023	258	1047	278	1067	295	1090	315	1115	337	1135	355	1159	377	1180	397				

Performance certified is for installation Type B: Free inlet, Ducted outlet. Power rating [BHP] does not include transmission losses. Performance ratings do not include the effects of appurtenances [accessories].

SIZE 73		AcustaFoil		Wheel diameter: 73.0" Wheel circumference: 19.1'				Capacity outlet area: 30.6 ft. ²				Maximum BHP = 423 $\left[\frac{\text{RPM}}{1000}\right]^3$									
CFM	OV	11"SP		12"SP		13"SP		14"SP		15"SP		16"SP		17"SP		18"SP		19"SP		20"SP	
		RPM	BHP	RPM	BHP	RPM	BHP	RPM	BHP	RPM	BHP	RPM	BHP	RPM	BHP	RPM	BHP	RPM	BHP	RPM	BHP
95000	3101	803	199	832	218	863	240	890	259	922	283	949	304	979	328	1002	347	1030	372	1055	395
101000	3296	815	212	842	231	869	251	898	273	925	295	954	318	978	339	1007	364	1034	388	1058	411
107000	3492	826	223	852	244	878	264	906	286	932	308	960	332	986	355	1010	377	1035	401	1061	427
113000	3688	839	236	867	259	892	280	916	300	941	323	968	347	993	371	1015	393	1043	420	1065	442
119000	3884	855	251	881	273	905	295	928	316	953	339	975	362	999	385	1024	411	1047	435	1071	461
125000	4080	871	266	896	289	917	310	943	334	964	355	989	381	1009	402	1033	428	1058	456		
131000	4275	891	284	913	306	934	328	956	351	979	376	1001	399	1024	424	1044	448	1066	473		
137000	4471	909	301	929	323	950	345	972	369	995	395	1016	420	1035	442	1055	467				
143000	4667	928	318	950	343	970	367	989	390	1009	414	1030	439	1052	466	1071	491				

SIZE 18		PLR		Wheel diameter: 18.25" Wheel circumference: 4.77'				Capacity outlet area: 1.92 ft. ²				Maximum BHP = 0.56 $\left[\frac{\text{RPM}}{1000}\right]^3$									
CFM	OV	11"SP		12"SP		13"SP		14"SP		15"SP		16"SP		17"SP		18"SP		19"SP		20"SP	
		RPM	BHP	RPM	BHP	RPM	BHP	RPM	BHP	RPM	BHP	RPM	BHP	RPM	BHP	RPM	BHP	RPM	BHP	RPM	BHP
5200	2708	3024	12.9	3144	14.2	3273	15.8	3390	17.3	3503	18.9	3623	20.6	3722	22.1	3827	23.8				
5800	3021	3044	13.7	3167	15.2	3280	16.6	3402	18.3	3510	19.8	3626	21.6	3724	23.1	3828	24.8	3938	26.7	4039	28.5
6400	3333	3104	15.0	3215	16.4	3316	17.8	3424	19.4	3540	21.1	3642	22.7	3750	24.5	3842	26.1	3950	28.0	4052	29.9
7000	3646	3165	16.3	3266	17.7	3374	19.3	3472	20.8	3576	22.5	3686	24.3	3783	26.0	3875	27.7	3972	29.5	4062	31.3
7600	3958	3241	17.8	3335	19.2	3433	20.8	3538	22.6	3633	24.2	3725	25.8	3822	27.6	3914	29.4	4011	31.3	4092	33.0
8200	4271	3330	19.5	3417	21.0	3509	22.6	3606	24.3	3693	25.9	3785	27.7	3882	29.6	3966	31.3	4054	33.2	4146	35.2
8800	4583	3429	21.4	3511	23.0	3597	24.6	3688	26.3	3769	28.0	3854	29.7	3944	31.6	4021	33.3	4118	35.5	4194	37.2
9400	4896	3537	23.6	3615	25.2	3697	26.8	3782	28.7	3858	30.3	3938	32.1	4021	34.0	4107	36.0	4182	37.8	4260	39.7
10000	5208	3648	25.9	3728	27.6	3806	29.4	3875	31.0	3959	32.9	4034	34.7	4111	36.7	4178	38.4	4262	40.5		

SIZE 22		PLR		Wheel diameter: 22.25" Wheel circumference: 5.82'				Capacity outlet area: 2.85 ft. ²				Maximum BHP = 1.40 $\left[\frac{\text{RPM}}{1000}\right]^3$									
CFM	OV	11"SP		12"SP		13"SP		14"SP		15"SP		16"SP		17"SP		18"SP		19"SP		20"SP	
		RPM	BHP	RPM	BHP	RPM	BHP	RPM	BHP	RPM	BHP	RPM	BHP	RPM	BHP	RPM	BHP	RPM	BHP	RPM	BHP
7000	2456	2499	19.4	2609	21.9	2709	24.4	2806	26.9	2910	29.8	2997	32.4	3101	36.4	3185	39.3	3274	42.4	3354	45.5
7900	2772	2521	20.4	2626	22.8	2721	25.2	2824	28.0	2914	30.6	3010	33.5	3112	37.6	3196	40.5	3285	43.7	3355	46.4
8800	3088	2556	21.6	2657	24.1	2749	26.5	2841	29.1	2938	32.0	3022	34.6	3112	37.6	3196	40.5	3285	43.7	3355	46.4
9700	3404	2614	23.4	2706	25.8	2790	28.2	2880	30.8	2959	33.3	3043	36.0	3132	39.0	3216	42.0	3295	44.9	3378	48.2
10600	3719	2683	25.5	2762	27.8	2847	30.3	2929	32.8	3002	35.2	3093	38.3	3166	40.9	3242	43.7	3322	46.8	3406	50.2
11500	4035	2763	28.0	2838	30.3	2917	32.8	2993	35.4	3061	37.7	3138	40.5	3220	43.5	3282	45.9	3363	49.2	3431	52.0
12400	4351	2851	30.8	2917	33.0	2992	35.5	3058	37.9	3133	40.7	3199	43.2	3268	45.9	3340	48.9	3415	52.0	3477	54.8
13300	4667	2948	34.0	3011	36.2	3077	38.7	3146	41.3	3211	43.9	3280	46.7	3344	49.5	3412	52.4	3475	55.3		
14200	4982	3048	37.4	3114	40.0	3177	42.5	3232	44.8	3300	47.7	3359	50.3	3420	53.1	3484	56.0				

SIZE 24		PLR		Wheel diameter: 24.5" Wheel circumference: 6.40'				Capacity outlet area: 3.45 ft. ²				Maximum BHP = 2.25 $\left[\frac{\text{RPM}}{1000}\right]^3$									
CFM	OV	11"SP		12"SP		13"SP		14"SP		15"SP		16"SP		17"SP		18"SP		19"SP		20"SP	
		RPM	BHP	RPM	BHP	RPM	BHP	RPM	BHP	RPM	BHP	RPM	BHP	RPM	BHP	RPM	BHP	RPM	BHP	RPM	BHP
9500	2754	2291	24.6	2382	27.4	2472	30.3	2560	33.4	2645	36.6	2725	39.7	2810	43.3						
10500	3043	2316	25.9	2405	28.8	2485	31.5	2580	35.0	2655	37.9	2736	41.1	2821	44.8	2901	48.4	2975	51.9	3054	55.7
11500	3333	2356	27.6	2444	30.6	2525	33.6	2596	36.3	2680	39.7	2752	42.7	2838	46.5	2910	49.8	2986	53.5	3066	57.6
12500	3623	2413	30.0	2490	32.8	2565	35.6	2644	38.9	2715	41.8	2789	45.1	2859	48.4	2933	51.9	3002	55.4	3074	59.2
13500	3913	2480	32.7	2547	35.3	2618	38.2	2692	41.4	2758	44.4	2827	47.6	2899	51.1	2967	54.5	3039	58.3	3106	61.9
14500	4203	2551	35.6	2615	38.3	2682	41.3	2747	44.3	2815	47.5	2879	50.7	2947	54.2	3004	57.2	3078	61.2	3140	64.8
15500	4493	2624	38.8	2691	41.8	2750	44.6	2812	47.7	2871	50.6	2938	54.2	2996	57.3	3063	61.0	3118	64.2	3176	67.7
16500	4783	2706	42.4	2766	45.3	2828	48.5	2882	51.4	2944	54.7	3003	58.0	3057	61.2	3121	64.9	3173	68.1		
17500	5072	2796	46.6	2849	49.4	2909	52.7	2961	55.7	3016	58.8	3072	62.2	3130	65.8	3184	69.2				

SIZE 27		PLR		Wheel diameter: 27.0" Wheel circumference: 7.06'				Capacity outlet area: 4.19 ft. ²				Maximum BHP = 4.20 $\left[\frac{\text{RPM}}{1000}\right]^3$									
CFM	OV	11"SP		12"SP		13"SP		14"SP		15"SP		16"SP		17"SP		18"SP		19"SP		20"SP	
		RPM	BHP	RPM	BHP	RPM	BHP	RPM	BHP	RPM	BHP	RPM	BHP	RPM	BHP	RPM	BHP	RPM	BHP	RPM	BHP
11500	2745	2033	28.1	2116	31.0	2206	34.4	2285	37.5	2361	40.7	2431	43.8								
13000	3103	2055	30.8	2135	33.8	2221	37.3	2298	40.6	2372	43.9	2442	47.1	2516	50.8	2584	54.3	2657	58.2	2722	61.9
14500	3461	2098	34.2	2176	37.5	2247	40.6	2323	44.1	2397	47.7	2459	50.8	2533	54.6	2602	58.4	2666	62.1	2734	66.0
16000	3819	2151	38.1	2218	41.2	2289	44.6	2358	48.1	2425	51.6	2488	55.0	2562	59.2	2625	62.9	2691	66.8	2751	70.6
17500	4177	2213	42.4	2276	45.6	2342	49.2	2406	52.8	2468	56.3	2533	60.2	2594	63.9	2659	68.0	2719	71.8	2781	76.0
19000	4535	2283	47.1	2342	50.6	2405	54.4	2460	57.7	2524	61.8	2578	65.3	2641	69.5	2694	73.1	2756	77.5	2814	81.6
20500	4893	2364	52.7	2422	56.5	2472	59.8	2529	63.7	2590	67.9	2641	71.6	2695	75.5	2751	79.7	2809	84.1	2863	88.3
22000	5251	2448	58.6	2499	62.3	2552	66.2	2607	70.4	2660	74.5	2709	78.3	2760	82.4	2813	86.7	2868	91.3		
23500	5609	2538	65.3	2587	69.3	2639	73.5	2688	77.5	2739	81.8	2781	85.4	2835	90.2	2880	94.2				

Performance certified is for installation Type B: Free inlet, Ducted outlet. Power rating [BHP] does not include transmission losses. Performance ratings do not include the effects of appurtenances [accessories].

SIZE 30		PLR		Wheel diameter: 30.0" Wheel circumference: 7.85'				Capacity outlet area: 5.17 ft. ²				Maximum BHP = 7.08 $\left[\frac{\text{RPM}}{1000}\right]^3$									
CFM	OV	11"SP		12"SP		13"SP		14"SP		15"SP		16"SP		17"SP		18"SP		19"SP		20"SP	
		RPM	BHP	RPM	BHP	RPM	BHP	RPM	BHP	RPM	BHP	RPM	BHP	RPM	BHP	RPM	BHP	RPM	BHP	RPM	BHP
14500	2805	1838	35.9	1911	39.6	1983	43.5	2060	47.9	2127	52.0	2198	56.5	2264	60.9	2333	69.3	2398	74.3	2457	79.0
16250	3143	1859	39.0	1930	42.9	2001	47.0	2069	51.2	2135	55.4	2205	60.1	2272	64.7	2333	69.3	2398	74.3	2457	79.0
18000	3482	1887	42.5	1957	46.7	2021	50.6	2089	55.1	2155	59.5	2218	64.0	2277	68.4	2340	73.2	2406	78.5	2466	83.6
19750	3820	1935	47.1	1996	51.0	2060	55.4	2117	59.4	2177	63.9	2241	68.7	2302	73.5	2366	78.8	2418	83.2	2473	88.0
21500	4159	1986	51.9	2044	56.0	2104	60.5	2163	65.1	2219	69.6	2278	74.5	2328	78.7	2387	83.8	2442	88.8	2499	94.2
23250	4497	2045	57.2	2099	61.6	2157	66.3	2207	70.6	2260	75.2	2316	80.2	2374	85.6	2423	90.2	2474	95.1	2527	100
25000	4836	2114	63.6	2167	68.3	2213	72.5	2266	77.4	2317	82.2	2364	86.9	2419	92.4	2465	97.1	2513	102	2563	107
26750	5174	2185	70.4	2232	75.0	2281	79.9	2328	84.6	2377	89.7	2422	94.6	2470	99.7	2519	105	2564	110		
28500	5513	2262	78.0	2304	82.5	2352	87.8	2393	92.3	2440	97.7	2489	103	2529	108	2571	113				

SIZE 33		PLR		Wheel diameter: 33.0" Wheel circumference: 8.63'				Capacity outlet area: 6.26 ft. ²				Maximum BHP = 11.6 $\left[\frac{\text{RPM}}{1000}\right]^3$									
CFM	OV	11"SP		12"SP		13"SP		14"SP		15"SP		16"SP		17"SP		18"SP		19"SP		20"SP	
		RPM	BHP	RPM	BHP	RPM	BHP	RPM	BHP	RPM	BHP	RPM	BHP	RPM	BHP	RPM	BHP	RPM	BHP	RPM	BHP
17000	2716	1666	42.0	1730	46.2	1799	51.1	1866	56.1	1929	61.1	1996	70.3	2060	76.2	2118	81.9	2171	87.3	2227	93.1
19200	3067	1686	45.7	1748	50.1	1815	55.2	1881	60.4	1937	65.1	1996	70.3	2060	76.2	2118	81.9	2171	87.3	2227	93.1
21400	3419	1717	50.3	1779	55.1	1834	59.5	1899	65.0	1955	70.0	2015	75.6	2072	81.1	2124	86.4	2187	93.1	2236	98.6
23600	3770	1757	55.8	1814	60.5	1870	65.4	1924	70.3	1982	75.8	2036	81.2	2087	86.5	2141	92.2	2197	98.6	2249	105
25800	4121	1804	62.0	1858	66.9	1911	71.9	1966	77.4	2014	82.3	2064	87.6	2117	93.4	2173	99.8	2219	105	2266	111
28000	4473	1857	69.0	1909	74.2	1959	79.4	2007	84.5	2057	90.0	2104	95.4	2154	101	2206	108	2254	114	2298	119
30200	4824	1921	77.4	1967	82.4	2015	87.9	2060	93.2	2103	98.4	2153	105	2195	110	2244	116	2289	122	2330	128
32400	5176	1986	86.3	2030	91.7	2073	97.0	2117	103	2163	109	2206	115	2251	121	2293	127	2336	133		
34600	5527	2056	96.3	2100	102	2142	108	2185	114	2220	119	2267	126	2305	132	2345	138				

SIZE 36		PLR		Wheel diameter: 36.5" Wheel circumference: 9.55'				Capacity outlet area: 7.66 ft. ²				Maximum BHP = 17.8 $\left[\frac{\text{RPM}}{1000}\right]^3$									
CFM	OV	11"SP		12"SP		13"SP		14"SP		15"SP		16"SP		17"SP		18"SP		19"SP		20"SP	
		RPM	BHP	RPM	BHP	RPM	BHP	RPM	BHP	RPM	BHP	RPM	BHP	RPM	BHP	RPM	BHP	RPM	BHP	RPM	BHP
21000	2742	1497	49.6	1558	55.0	1619	60.6	1677	66.4	1732	72.3	1792	78.9	1847	85.4	1897	91.6	1950	98.5		
23600	3081	1516	53.9	1576	59.6	1630	64.9	1687	70.9	1743	77.0	1795	83.1	1850	89.9	1902	96.5	1956	104	2005	111
26200	3420	1545	59.1	1600	64.7	1648	69.9	1706	76.3	1755	82.1	1808	88.6	1864	95.8	1910	102	1959	109	2010	116
28800	3760	1581	65.0	1632	70.7	1682	76.5	1730	82.3	1781	88.8	1829	95.1	1880	102	1928	109	1972	115	2025	123
31400	4099	1623	71.5	1671	77.5	1718	83.5	1768	90.1	1811	96.0	1856	102	1903	109	1953	117	1994	123	2036	130
34000	4439	1674	79.3	1717	85.2	1762	91.5	1805	97.7	1850	104	1892	111	1937	118	1978	125	2021	132	2061	139
36600	4778	1731	88.0	1768	93.7	1812	100	1853	107	1892	113	1937	121	1975	127	2014	134	2055	142	2097	149
39200	5117	1789	97.0	1825	103	1864	110	1904	117	1946	124	1980	131	2021	138	2058	145	2097	153	2133	160
41800	5457	1852	107	1888	114	1925	121	1961	128	1997	135	2035	143	2070	150	2106	157	2139	164		

SIZE 40		PLR		Wheel diameter: 40.25" Wheel circumference: 10.5'				Capacity outlet area: 9.31 ft. ²				Maximum BHP = 29.2 $\left[\frac{\text{RPM}}{1000}\right]^3$									
CFM	OV	11"SP		12"SP		13"SP		14"SP		15"SP		16"SP		17"SP		18"SP		19"SP		20"SP	
		RPM	BHP	RPM	BHP	RPM	BHP	RPM	BHP	RPM	BHP	RPM	BHP	RPM	BHP	RPM	BHP	RPM	BHP	RPM	BHP
28000	3008	1375	65.0	1427	71.3	1488	79.3	1538	86.1	1591	93.8	1641	101	1693	115	1743	124	1790	133		
31000	3330	1390	70.0	1446	77.5	1497	84.6	1547	91.8	1600	100	1645	107	1693	115	1743	124	1790	133		
34000	3652	1417	76.4	1465	83.3	1517	91.1	1562	98.3	1611	106	1657	114	1706	123	1752	131	1794	140	1839	148
37000	3974	1455	84.1	1496	90.7	1545	98.8	1587	106	1632	114	1680	123	1720	131	1763	139	1807	148	1848	157
40000	4296	1497	92.6	1537	99.7	1579	107	1620	115	1663	123	1703	131	1745	140	1785	149	1826	158	1864	166
43000	4619	1540	101	1579	109	1620	117	1659	125	1696	133	1734	141	1770	149	1812	159	1846	167	1887	177
46000	4941	1589	111	1627	120	1663	128	1697	135	1736	144	1769	152	1808	161	1843	170	1880	180	1914	188
49000	5263	1642	122	1676	131	1711	139	1745	147	1779	156	1811	164	1848	174	1883	183	1914	192		
52000	5585	1700	135	1730	143	1762	152	1798	161	1828	170	1859	178	1892	188	1925	197				

SIZE 44		PLR		Wheel diameter: 44.5" Wheel circumference: 11.6'				Capacity outlet area: 11.4 ft. ²				Maximum BHP = 48.2 $\left[\frac{\text{RPM}}{1000}\right]^3$									
CFM	OV	11"SP		12"SP		13"SP		14"SP		15"SP		16"SP		17"SP		18"SP		19"SP		20"SP	
		RPM	BHP	RPM	BHP	RPM	BHP	RPM	BHP	RPM	BHP	RPM	BHP	RPM	BHP	RPM	BHP	RPM	BHP	RPM	BHP
34000	2985	1241	78.7	1293	87.3	1340	95.5	1390	105	1439	114	1485	124	1528	133	1574	143	1615	153		
37800	3319	1259	85.8	1307	94.3	1353	103	1399	112	1448	122	1489	131	1533	141	1579	152	1616	161		
41600	3652	1284	93.8	1328	102	1372	111	1418	121	1458	130	1500	140	1540	150	1582	160	1626	172	1661	181
45400	3986	1318	103	1356	112	1397	121	1436	130	1477	140	1517	150	1558	160	1597	171	1638	182	1669	191
49200	4320	1356	114	1393	123	1432	133	1470	142	1505	151	1542	161	1576	171	1617	183	1650	192	1689	204
53000	4653	1399	126	1432	134	1469	145	1501	154	1539	164	1570	174	1607	185	1641	196	1677	207	1709	218
56800	4987	1446	139	1478	148	1511	158	1542	168	1575	178	1609	189	1641	200	1673	211	1703	221	1738	233
60600	5320	1497	153	1525	162	1558	173	1589	184	1617	194	1646	204	1677	215	1708	227	1741	239	1771	250
64400	5654	1549	169	1577	179	1606	190	1637	201	1664	212	1693	223	1723	234	1750	245	1778	256		

Performance certified is for installation Type B: Free inlet, Ducted outlet. Power rating [BHP] does not include transmission losses. Performance ratings do not include the effects of appurtenances [accessories].

SIZE 49		PLR		Wheel diameter: 49.0" Wheel circumference: 12.8'				Capacity outlet area: 13.8 ft. ²				Maximum BHP = 78.0 $\left[\frac{\text{RPM}}{1000}\right]^3$									
CFM	OV	11"SP		12"SP		13"SP		14"SP		15"SP		16"SP		17"SP		18"SP		19"SP		20"SP	
		RPM	BHP	RPM	BHP	RPM	BHP	RPM	BHP	RPM	BHP	RPM	BHP	RPM	BHP	RPM	BHP	RPM	BHP	RPM	BHP
40000	2899	1127	94.2	1173	104	1217	114	1261	125	1307	137	1346	147	1393	169	1432	181	1467	193	1510	207
44500	3225	1137	101	1182	112	1227	123	1266	133	1312	145	1351	156	1396	178	1436	191	1473	204	1512	218
49000	3551	1158	110	1200	121	1241	132	1280	143	1322	155	1358	166	1396	178	1436	191	1473	204	1512	218
53500	3877	1184	121	1223	132	1261	143	1298	154	1334	165	1375	179	1410	190	1447	203	1481	215	1516	229
58000	4203	1217	133	1252	144	1288	155	1323	167	1356	178	1391	190	1424	202	1458	215	1494	229	1527	242
62500	4529	1254	146	1288	158	1320	169	1350	180	1386	193	1415	205	1450	218	1478	230	1512	244	1547	259
67000	4855	1295	161	1325	173	1357	185	1386	197	1417	209	1445	221	1475	234	1506	247	1538	261	1567	275
71500	5181	1338	177	1367	190	1395	201	1423	214	1453	227	1481	240	1510	253	1540	267	1567	281	1595	294
76000	5507	1384	195	1413	209	1437	220	1465	234	1492	246	1519	260	1543	272	1572	287	1599	301		

SIZE 54		PLR		Wheel diameter: 54.25" Wheel circumference: 14.2'				Capacity outlet area: 16.9 ft. ²				Maximum BHP = 130 $\left[\frac{\text{RPM}}{1000}\right]^3$									
CFM	OV	11"SP		12"SP		13"SP		14"SP		15"SP		16"SP		17"SP		18"SP		19"SP		20"SP	
		RPM	BHP	RPM	BHP	RPM	BHP	RPM	BHP	RPM	BHP	RPM	BHP	RPM	BHP	RPM	BHP	RPM	BHP	RPM	BHP
49000	2896	1016	115	1057	127	1102	141	1142	154	1179	167	1219	182	1257	196	1291	210	1325	236	1358	251
54700	3233	1029	125	1070	138	1107	150	1146	164	1184	178	1220	192	1258	207	1293	222	1325	236	1358	251
60400	3570	1048	136	1086	150	1119	162	1155	175	1194	190	1226	204	1260	218	1297	235	1330	250	1365	267
66100	3907	1074	150	1107	163	1142	177	1175	190	1207	204	1241	219	1273	234	1306	250	1337	265	1369	281
71800	4243	1104	165	1135	179	1166	192	1197	206	1228	220	1259	236	1293	252	1320	266	1353	283	1383	300
77500	4580	1140	183	1168	196	1197	210	1225	224	1254	239	1284	255	1312	270	1341	286	1368	301	1400	320
83200	4917	1177	201	1204	216	1230	229	1260	246	1284	260	1310	275	1337	291	1365	307	1395	325	1418	340
88900	5254	1220	223	1244	238	1269	253	1296	269	1320	284	1345	299	1372	316	1395	332	1420	348		
94600	5591	1263	247	1285	261	1310	277	1333	292	1357	309	1382	326	1404	341	1427	358				

SIZE 60		PLR		Wheel diameter: 60.0" Wheel circumference: 15.7'				Capacity outlet area: 20.7 ft. ²				Maximum BHP = 215 $\left[\frac{\text{RPM}}{1000}\right]^3$									
CFM	OV	11"SP		12"SP		13"SP		14"SP		15"SP		16"SP		17"SP		18"SP		19"SP		20"SP	
		RPM	BHP	RPM	BHP	RPM	BHP	RPM	BHP	RPM	BHP	RPM	BHP	RPM	BHP	RPM	BHP	RPM	BHP	RPM	BHP
58000	2802	918	138	953	152	992	168	1029	184	1064	200	1102	219	1133	235	1167	267	1202	288	1229	304
65000	3140	927	149	962	164	997	179	1033	196	1069	214	1103	231	1134	248	1167	283	1202	302	1231	321
72000	3478	942	163	977	179	1009	194	1042	211	1075	228	1109	246	1141	265	1171	283	1203	302	1231	321
79000	3816	964	178	994	194	1026	211	1058	228	1088	245	1119	264	1149	282	1180	301	1209	320	1239	341
86000	4155	989	196	1021	214	1049	230	1078	248	1103	263	1136	284	1164	302	1189	320	1216	338	1248	361
93000	4493	1022	218	1048	234	1075	251	1101	268	1127	286	1156	306	1182	325	1206	342	1234	364	1260	384
100000	4831	1056	241	1079	256	1105	275	1130	293	1156	313	1180	331	1205	350	1228	369	1252	388	1280	412
107000	5169	1093	266	1115	284	1139	302	1160	319	1186	340	1209	359	1230	377	1256	399	1279	420	1303	441
114000	5507	1131	293	1153	312	1176	332	1198	351	1220	371	1240	389	1261	408	1285	432	1304	450		

SIZE 66		PLR		Wheel diameter: 66.0" Wheel circumference: 17.3'				Capacity outlet area: 25.0 ft. ²				Maximum BHP = 346 $\left[\frac{\text{RPM}}{1000}\right]^3$									
CFM	OV	11"SP		12"SP		13"SP		14"SP		15"SP		16"SP		17"SP		18"SP		19"SP		20"SP	
		RPM	BHP	RPM	BHP	RPM	BHP	RPM	BHP	RPM	BHP	RPM	BHP	RPM	BHP	RPM	BHP	RPM	BHP	RPM	BHP
70000	2798	834	166	870	185	905	205	936	222	968	243	999	262	1031	285	1061	323	1088	345	1117	369
79000	3157	842	180	877	200	908	219	942	240	971	259	1002	280	1035	304	1061	345	1095	369	1121	391
88000	3517	857	198	889	218	918	236	949	257	978	278	1009	301	1039	323	1066	369	1095	390	1121	391
97000	3877	881	220	906	238	936	259	964	280	992	301	1017	321	1044	343	1072	367	1098	369	1126	415
106000	4237	908	244	932	263	958	283	985	305	1007	324	1034	348	1059	370	1086	394	1110	417	1135	442
115000	4596	937	271	960	291	985	313	1009	334	1033	356	1056	378	1080	401	1105	426	1124	446	1152	475
124000	4956	971	301	992	321	1016	345	1036	365	1060	389	1082	413	1102	434	1126	460	1148	484	1170	510
133000	5316	1008	335	1028	357	1050	381	1070	403	1091	426	1109	448	1132	474	1152	498	1173	524		
142000	5675	1047	374	1065	396	1084	419	1104	443	1122	465	1143	492	1162	516	1182	542				

SIZE 73		PLR		Wheel diameter: 73.0" Wheel circumference: 19.1'				Capacity outlet area: 30.6 ft. ²				Maximum BHP = 572 $\left[\frac{\text{RPM}}{1000}\right]^3$									
CFM	OV	11"SP		12"SP		13"SP		14"SP		15"SP		16"SP		17"SP		18"SP		19"SP		20"SP	
		RPM	BHP	RPM	BHP	RPM	BHP	RPM	BHP	RPM	BHP	RPM	BHP	RPM	BHP	RPM	BHP	RPM	BHP	RPM	BHP
90000	2937	756	210	787	232	817	256	847	280	875	303	905	330	933	375	959	402	987	432		
100000	3264	766	228	795	250	822	273	852	298	880	324	908	350	933	375	959	402	987	432		
110000	3590	780	249	807	271	835	297	860	320	886	345	914	373	937	397	964	427	990	456	1013	483
120000	3916	798	272	823	295	847	319	873	345	897	370	923	398	947	425	973	455	993	479	1018	510
130000	4243	820	299	844	324	868	349	890	373	913	400	935	425	958	453	981	482	1003	511	1026	541
140000	4569	845	329	867	353	889	380	910	406	930	431	954	461	976	489	995	516	1019	549	1038	575
150000	4896	873	362	894	389	914	415	932	440	954	469	974	497	992	523	1014	555	1034	585	1055	616
160000	5222	903	400	922	426	941	455	960	481	979	510	996	536	1016	567	1035	597	1054	628		
170000	5548	934	440	952	469	970	496	988	525	1004	552	1024	584	1041	614	1059	645				

Performance certified is for installation Type B: Free inlet, Ducted outlet. Power rating [BHP] does not include transmission losses. Performance ratings do not include the effects of appurtenances [accessories].

CONSTRUCTION FEATURES

All-welded construction—provides strength and durability for extended service life in a wide range of applications.

Heavy-gauge steel housing—rigidly supported with structural bracing...Sizes 18-33 are rotatable in 22½° increments...Sizes 36-73 have fixed housings.

Lifting eyes—standard on all sizes.

Finish—two-coat paint system consisting of one prime coat and one finish coat of medium-green enamel.

Shafting—turned, ground, and polished shafting is straightened to close tolerance to minimize “run out” and ensure smooth operation. This, coupled with proper shaft-to-bearing fit, maximizes bearing operating life.

Bearings—spherical roller bearings selected for ample service factor for full performance range.

Precision balancing—all AcoustaFoil and PLR wheels are statically and dynamically balanced before final assembly. After assembly, all fans are balanced on a rigid test pad at the specified running speed.

MATERIAL SPECIFICATIONS [DIMENSIONS IN INCHES]

Size	Housing					Bearing pedestal					
	Scroll	Side sheet	Side angle†	Base bar	Inlet collar	Arrangement 1 and 8				Arr. 3 and 7	
						Bearing bar	Pedestal top	Pedestal side	Bearing	Bearing bar	Bearing
18	10	10	—	3 x 3/8	10	3 x 3/8	3/8	1/4	G	—	—
22	10	10	—	3 x 3/8	10	3 x 3/8	3/8	1/4	G	—	—
24	10	10	—	4 x 1/2	10	4 x 1/2	3/8	1/4	G	—	—
27	10	10	—	4 x 1/2	10	4 x 1/2	1/2	3/8	G	—	—
30	10	10	—	4 x 1/2	10	4 x 1/2	1/2	3/8	G	3 x 3/8	E
33	7	7	—	4 x 1/2	10	4 x 1/2	1/2	3/8	G	4 x 1/2	E
36	7	7	A	3 x 3/8	7	4 x 1/2	1/2	3/8	G	4 x 1/2	E
40	7	7	A	3 x 3/8	7	5 x 5/8	1/2	3/8	G	4 x 1/2	E
44	7	7	A	3 x 3/8	7	5 x 5/8	1/2	3/8	G	4 x 1/2	E
49	7	7	A	3 x 3/8	7	5 x 5/8	1/2	3/8	G	5 x 5/8	E
54	7	7	B	4 x 1/2	7	5 x 5/8	1/2	3/8	G	5 x 5/8	E
60	7	7	B	4 x 1/2	7	6 x 3/4	1/2	3/8	G	5 x 5/8	E
66	7	7	C	5 x 5/8	7	6 x 3/4	1/2	3/8	G	5 x 5/8	E
73	7	7	C	5 x 5/8	7	7 x 1	1/2	3/8	G	7 x 1	F

Bearing types: E = LinkBelt 22400 spherical roller bearing. F = LinkBelt 22500 spherical roller bearing.

G = LinkBelt 6800 spherical roller bearing. **nyb** reserves the right to substitute bearings of equal rating.

† Dimensions indicated by letter are in inches as follows: A = 3 x 2 x 3/16; B = 4 x 3 x 1/4; C = 5 x 3 1/2 x 5/16.

MATERIAL SPECIFICATIONS [DIMENSIONS IN INCHES]

Size	Shaft		Acoustafoil		PLR		Bare fan weight [lbs.]			
	Arrangement 1 and 8	Arrangement 3 and 7	Wheel weight [lbs.]	WR² [lb-ft²]	Wheel weight [lbs.]	WR² [lb-ft²]	Arrangement 1		Arrangement 3	
							AcF	PLR	AcF	PLR
18	1 1/16	—	49	14	48	12	362	359	—	—
22	1 5/16	—	73	36	67	32	495	489	—	—
24	2 3/16	—	100	54	100	53	665	665	—	—
27	2 7/16	—	115	78	117	78	905	907	—	—
30	2 7/16	2 3/16	151	120	152	120	1191	1192	990	991
33	2 1 1/16	2 3/16	180	185	173	170	1532	1525	1197	1190
36	2 15/16	2 7/16	268	316	261	298	1782	1775	1414	1407
40	3 7/16	2 1 1/16	310	503	339	514	2153	2182	1730	1759
44	3 7/16	2 15/16	410	814	438	860	2731	2759	2342	2370
49	3 15/16	2 15/16	631	1307	661	1362	3247	3277	2599	2629
54	3 15/16	3 7/16	788	2125	824	2200	4347	4383	3503	3539
60	4 7/16	3 15/16	916	3103	953	3205	5407	5444	4094	4131
66	4 15/16	3 15/16	1262	5337	1209	4831	7459	7406	6193	6140
73	5 7/16	4 7/16	1536	8172	1465	7480	8385	8314	6817	6746

FLANGE DIMENSIONS

FLANGED INLET OPTION

Holes furnished on vertical centerline.

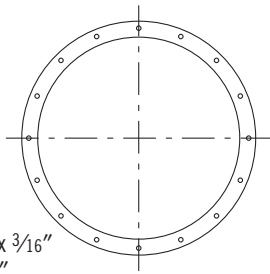

Note: Inlet-flange angles:
 Sizes 18-22 . . 1½" x 1½" x ⅜"
 Sizes 24-73 . . 2" x 2" x ⅜"

DIMENSIONS [INCHES]

Size	ID	BC	OD	Holes	
				No.	Dia.
18	20	21¾	23	16	⅞
20‡	21¾	23½	24¾	16	⅞
22	24¾	26½	27¾	16	⅞
24	26⅞	29⅞	30⅞	16	⅞
27	29½	31¾	33½	16	⅞
30	32⅞	35⅞	36⅞	16	⅞
33	36⅞	38¾	40⅞	16	⅞
36	40⅞	42¾	44⅞	16	⅞
40	43⅞	46⅞	47⅞	24	⅞
44	48⅞	51⅞	52⅞	24	⅞
49	53⅞	56⅞	57⅞	24	⅞
54	59¾	61⅞	63¾	24	⅞
60	66⅞	68¾	70⅞	32	⅞
66	72¾	74⅞	76¾	32	⅞
73	80¾	82⅞	84¾	32	⅞

‡ Note: Size 20 fan is only available in Arrangement 4 options.

Tolerance: ± ⅛"

FLANGED OUTLET OPTION

1. Flange face mounted flush with outside edge of housing discharge.
2. Holes furnished on 4" centers from centerlines.
3. For alloy construction:
 Sizes 18-22 . . 1¼" x 1¼" x ⅜" angle.

NOTE: Outlet-flange angles or material gauge:
 Sizes 12-22* . . 7 gauge plate.
 Sizes 24-33 . . 1½" x 1½" x ⅜" angle.
 Sizes 36-73 . . 2" x 2" x ⅜" angle.

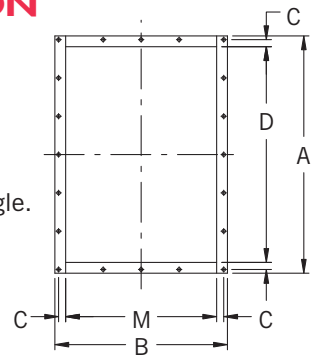

DIMENSIONS [INCHES]

Size	A*	B†*	C	D•	M•†	Holes/flange		Hole dia.
						Sides	†Top/bottom	
18	23½	16⅞	¾	20½	13½	5	3	⅞
20	25⅞	18	¾	22⅞	15½	7	3	⅞
22	27⅞	19⅞	¾	24⅞	16½	7	3	⅞
24	30¾	21½	⅞	27¾	18½	7	5	⅞
27	33¼	23¾	⅞	30¼	20¾	9	5	⅞
30	36½	25¾	⅞	33½	22¾	9	5	⅞
33	39¾	27⅞	⅞	36⅞	24⅞	9	5	⅞
36	44¾	31½	1⅞	40¾	27½	11	7	⅞
40	48⅞	34¾	1⅞	44⅞	30¾	11	7	⅞
44	53¾	37½	1⅞	49¾	33½	13	7	⅞
49	58¾	40⅞	1⅞	54¾	36⅞	15	9	⅞
54	64¾	44¾	1⅞	60¾	40¾	15	9	⅞
60	70⅞	49	1⅞	66⅞	45	17	11	⅞
66	77½	53½	1⅞	73½	49½	19	11	⅞
73	85¼	58¾	1⅞	81¼	54¾	21	13	⅞

† Dimensions will vary with narrow-width construction.

Tolerance: ± ⅛"

• Dimension shown is inside flange, outside housing, Deduct housing material thicknesses to determine inside dimensions of discharge.

* Materials of construction for mild steel only. Alloy construction uses angle on all sizes. A and B dimensions will vary in Sizes 18-22.

ARRANGEMENT 4 AVAILABILITY

ARRANGEMENT

4



Traditional arrangement utilizing fan pedestal and foot-mounted motor. Seven discharge positions are available to meet requirements.

Max. temperature: 180°F.

ARRANGEMENT

4-F

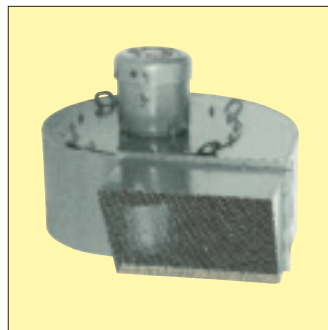

Most compact arrangement with motor mounting directly to housing and fan flush-mounted to the customer's mating surface.

Max. temperature: 120°F.

ARRANGEMENT

4-H



Designed for mounting so the fan shaft is horizontal. Motor mounts directly to the fan housing. Fan is flange-mounted to the customer's mating surface.

Max. temperature: 120°F.

ARRANGEMENT

4-V



Similar to the 4-F. Designed for mounting so the fan shaft is vertical. Motor mounts directly to fan housing. Fan is flange-mounted to the customer's mating surface.

Max. temperature: 120°F.

ARRANGEMENT 7 AND 8 MOTOR PEDESTAL DIMENSIONS

These approximate dimensions can be used to estimate the overall size of Arrangement 7 and 8 fans. Add the appropriate dimensions below to fan dimensions on page 15.

Note: coupling gap is based on the FALK STEELFLEX coupling sizes shown. As the gap will vary with other coupling sizes or types, so will the Arrangement 7 or 8 motor pedestal dimensions.

DIMENSIONS [INCHES]

Motor frame size	Coupling		O-O*		H-H*			
	Size	Gap	Min.	Max.	Open		TE	
					Min.	Max.	Min.	Max.
143 -145T	30T	1/8	3/4	3 1/8	10 7/8	12 1/2	11 5/8	13 1/4
182 -184T	40T	1/8	3/4	3 5/8	12 7/8	14 3/4	14 5/8	15 3/4
213 -215T	50T	1/8	1 3/8	5 1/2	15 7/8	17 3/8	17 7/8	20
254 -256T	60T	1/8	1	5 7/8	20 5/8	22 1/2	22 1/2	25 1/2
284 -286T	70T	1/8	1 1/2	6 3/8	23 1/2	25 1/8	25 3/8	28 3/8
284TS-286TS	70T	1/8	1 1/2	6 1/2	22 1/8	23 3/4	24 1/8	27 1/8
324 -326T	80T	1/8	1	6 3/4	26 1/8	27 3/4	28 1/4	31 7/8
324TS-326TS	80T	1/8	1	6 3/4	24 5/8	26 1/8	26 3/4	30 3/8
364 -365T	90T	1/8	1 1/8	7	28 1/4	29 7/8	32 1/2	34 1/8
364TS-365TS	90T	1/8	1 5/8	7	26 5/8	27 5/8	30 3/8	32
404 -405T	90T	1/8	2 3/8	8 3/4	32 5/8	34 1/4	37 3/8	39
404TS-405TS	90T	1/8	2 3/8	8 3/4	29 5/8	31 1/4	34 3/8	36
444 -445T	100T	3/16	1 5/8	9 3/8	37 3/8	40	42	45 1/8
444TS-445TS	100T	3/16	2 1/8	9 3/8	34 1/8	36 1/4	38 3/8	41 3/8

*H-H and O-O based on several major motor manufacturers—consult **nyb** for exact dimensions. Dimensions not to be used for construction unless certified.

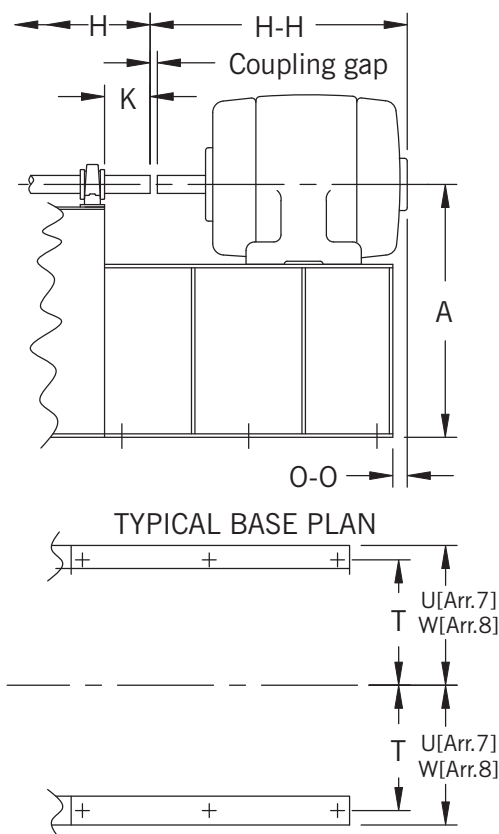

ANGULAR DISCHARGE DIMENSIONS [INCHES]

Size	a	b		c	d
		BAU TAU	TAD		
18	17 1/4	23 5/8	23 5/8	19 1/4	13 7/8
22	21 1/8	28 3/4	28 3/4	23 1/4	16 7/8
24	23 1/8	31 7/8	31 7/8	25 3/4	18 1/2
27	25 1/2	34 3/4	34 3/4	28 3/8	20 1/2
30	28 3/8	38 3/8	38 3/8	31 1/2	22 3/4
33	31 1/4	42 1/8	42 1/8	34 5/8	25 1/4
36	34 1/2	47 7/8	56 1/4	38 1/4	27 1/2
40	38	52 3/4	61 3/8	42 1/4	30
44	42 1/8	57 1/4	67 1/8	46 5/8	33 3/4
49	46 1/4	61 5/8	73 5/8	51 3/8	36 5/8
54	51 1/4	68 7/8	80 7/8	56 7/8	41 1/8
60	56 5/8	75 1/2	89 3/8	61 7/8	45 3/8
66	62 3/8	82 3/4	97 7/8	69 1/8	50
73	68 7/8	91 1/8	107 1/2	76 1/2	55 1/4

FAN DISCHARGES – VIEWED FROM DRIVE SIDE

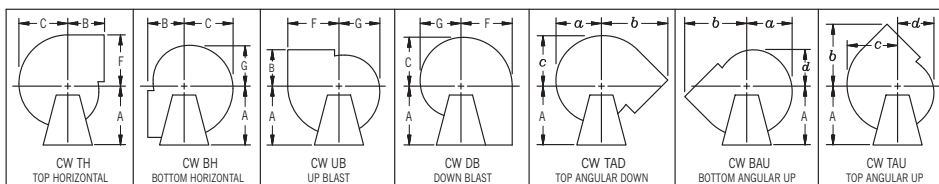

Clockwise—angular discharges at 45°

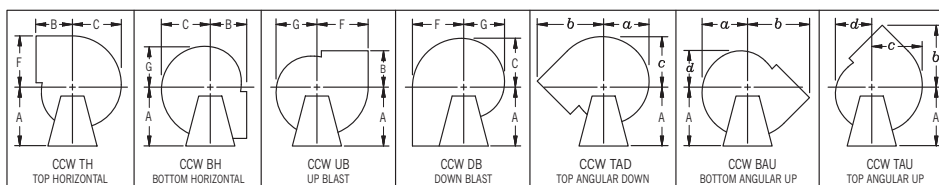

Counterclockwise—angular discharges at 45°

Down Blast and Top Angular Down discharge positions must be evaluated for clearance of accessories such as flanged outlet, outlet damper, unitary base, etc. Consult **nyb** with specific details.

ARRANGEMENT 1

SIZES 18 TO 33

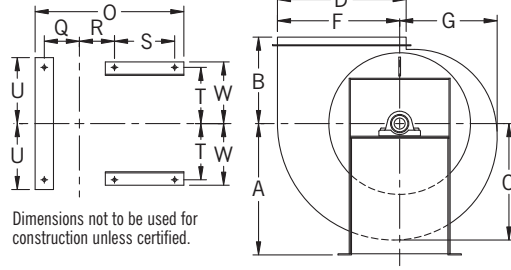
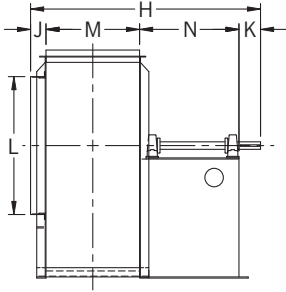

SIZES 36 TO 73

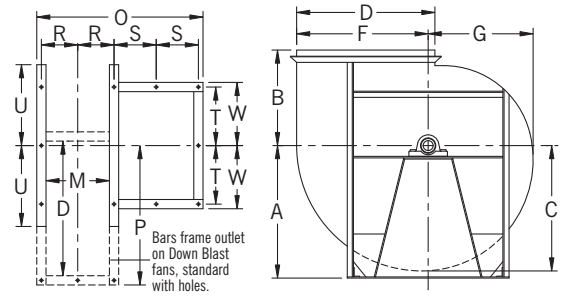

DIMENSIONS [INCHES]

Size	A				B		C	D	E	F	G	H	J	K	L	M	N	O	Q		R	S	T	U	W	Key	Base holes
	TH TAD	BH BAU	UB TAU	DB	*	TAD													P	P							
18	21 3/4	21 3/4	21 3/4	21 3/4	14	14	18 1/2	20 1/2	11 3/4	19 3/8	15 1/2	35 1/2	3 1/8	4 1/2	20 3/4	13 7/8	14	31 1/8	8 3/4	8 1/2	10 7/8	9 3/8	10 7/8	10 7/8	10 1/4	3/8	9/16
22	26	26	26	26	17	17	22 1/2	24 7/8	14 3/8	23 5/8	18 7/8	43 1/2	3 3/8	5	25 1/8	16 7/8	18 1/2	38 5/8	10 1/4	10	15 3/8	10 7/8	12 5/8	11 3/4	1/2	9/16	
24	28 5/8	28 5/8	28 5/8	28 5/8	19	19	24 3/4	27 3/8	15 3/4	26	20 3/4	47 5/8	4 1/8	5 1/2	27 5/8	18 1/2	19 1/2	42 1/4	11 1/2	11 3/8	15 3/8	12 1/4	14 3/8	13 1/2	1/2	3/4	
27	31 1/8	31 1/8	31 1/8	31 1/8	20 1/2	20 1/2	27 1/4	30 1/4	17 3/8	28 5/8	22 7/8	52	4 1/8	6	30 1/4	20 3/8	21 1/2	46 1/8	12 1/2	12 1/4	17 3/8	13 5/8	15 1/2	14 7/8	5/8	3/4	
30	34 3/4	34 3/4	34 3/4	34 3/4	22 1/2	22 1/2	30 3/8	33 1/2	19 3/8	31 7/8	25 3/8	57 1/4	4 1/8	6 1/2	33 5/8	22 5/8	24	50 7/8	13 5/8	13 3/8	19 7/8	14 7/8	16 7/8	16 1/8	5/8	3/4	
33	37 3/4	37 3/4	37 3/4	37 3/4	24 1/2	24 1/2	33 3/8	36 7/8	21 1/4	35	28	62 1/2	4 1/8	7	36 7/8	24 7/8	26 1/2	55 5/8	14 3/4	14 1/2	22 3/8	16	18 1/4	17 1/4	5/8	3/4	
36	33	42	39	29	29	41 3/4	36 7/8	40 3/4	23 1/2	38 3/4	30 7/8	67	5	7 1/2	41	27 1/2	27	60 1/2	40 1/4	15 1/4	13 1/2	17 1/2	24 1/2	19	3/4	7/8	
40	36	46	43	31	31	45 1/4	40 3/4	44 7/8	26	42 3/4	34 1/8	73 3/8	5	8	44 3/4	30 3/8	30	66 3/8	44 1/4	16 3/4	15	19	26 1/4	20 1/2	7/8	7/8	
44	40	50	47	33 1/2	33 1/2	49	45	49 5/8	28 5/8	47 1/8	37 3/4	80	5	8 1/2	49 3/4	33 1/2	33	72 1/2	48 5/8	18 1/4	16 1/2	21	28 3/4	22 1/2	7/8	7/8	
49	43 1/2	55	51 1/2	36	36	53 1/4	49 1/2	54 5/8	31 5/8	52	41 1/2	86 7/8	5	9	54 3/4	36 7/8	36	78 7/8	53 1/2	20	18	23	31 1/4	24 1/2	1	7/8	
54	48	60 1/2	57	40	40	58 3/4	54 7/8	60 3/8	35	57 1/2	45 7/8	96 1/4	6	9 1/2	60 1/4	40 3/4	40	88 3/4	59 1/2	22 3/8	20	25	35	27	1	1	
60	53	66 1/2	62 1/2	43	43	64 1/2	60 3/4	66 7/8	38 3/4	63 3/4	50 7/8	106	6	10	67	45	45	98	65 3/4	24 1/2	22 1/2	26 1/2	38 1/2	28 1/2	1	1	
66	58	73	69	47	47	70 1/4	66 3/4	73 1/2	42 5/8	70	56	116	7	10 1/2	73 1/2	49 1/2	49	108 1/2	72 1/2	27 1/4	24 1/2	29	42 1/4	31 1/2	1 1/4	1	
73	64	80 1/2	76	51 1/2	51 1/2	76 1/2	73 7/8	81 1/4	47 1/8	77 1/2	61 7/8	126 3/4	7	11	81 1/2	54 3/4	54	118 3/4	80	29 7/8	27	33 1/2	46 1/4	36	1 1/4	1	

* For TH, BH, UB, DB, BAU, and TAU discharges.

Tolerance: ± 1/8"

ARRANGEMENT 3

SIZES 30 AND 33

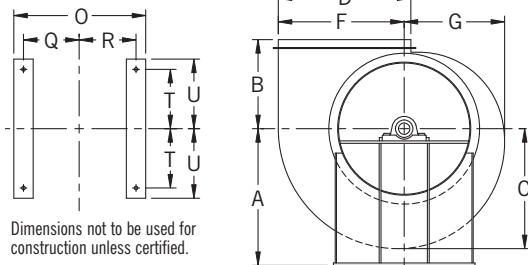
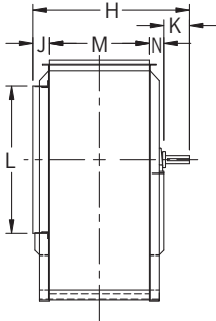

SIZES 36 TO 73

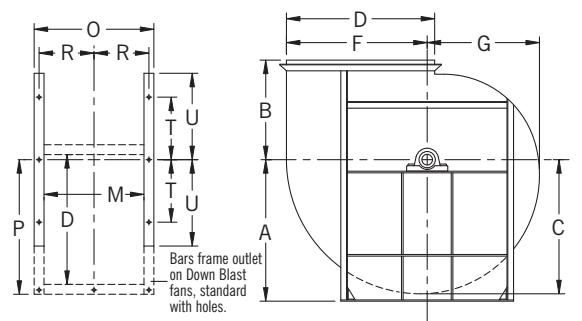

DIMENSIONS [INCHES]

Size	A				B		C	D	E	F	G	H	J	K	L	M	N	O	Q		R	S	U	Key	Base holes
	TH TAD	BH BAU	UB TAU	DB	*	TAD													P	P					
30	33 3/4	33 3/4	33 3/4	33 3/4	22 1/2	22 1/2	30 3/8	33 1/2	19 3/8	31 7/8	25 3/8	37	4 1/8	6 1/2	33 5/8	22 5/8	33 1/4	13 5/8	13 5/8	14 3/4	14 3/4	16	18 1/4	1/2	3/4
33	37	37	37	37	24 1/2	24 1/2	33 3/4	36 7/8	21 1/4	35	28	41 1/4	5 1/8	7	36 7/8	24 7/8	41 1/4	33 1/2	14 3/4	40 3/4	15 1/4	17 1/2	24 1/2	5/8	7/8
36	33	42	39	29	29	41 3/4	36 7/8	40 3/4	23 1/2	38 3/4	30 7/8	45 1/4	6	7 1/2	41	27 1/2	41 1/4	33 1/2	40 3/4	15 1/4	17 1/2	24 1/2	5/8	7/8	
40	36	46	43	31	31	45 1/4	40 3/4	44 7/8	26	42 3/4	34 1/8	49 7/8	7	8	44 3/4	30 3/8	41 1/2	36 3/8	44 1/4	16 3/4	19	26 1/4	5/8	7/8	
44	40	50	47	33 1/2	33 1/2	49	45	49 5/8	28 5/8	47 1/8	37 3/4	53 1/2	7	8 1/2	49 3/4	33 1/2	41 1/2	39 1/2	48 5/8	18 1/4	21	28 3/4	3/4	7/8	
49	43 1/2	55	51 1/2	36	36	53 1/4	49 1/2	54 5/8	31 5/8	52	41 1/2	57 7/8	7	9	54 3/4	36 7/8	5	42 7/8	53 1/2	20	23	31 1/4	3/4	7/8	
54	48	60 1/2	57	40	40	58 3/4	54 7/8	60 3/8	35	57 1/2	45 7/8	62 1/2	7	9 1/2	60 1/4	40 3/4	51 1/4	48 3/4	59 1/2	22 3/8	25	35	27	1	1
60	53	66 1/2	62 1/2	43	43	64 1/2	60 3/4	66 7/8	38 3/4	63 3/4	50 7/8	67 5/8	7	10	67	45	55 5/8	53	65 3/4	24 1/2	26 1/2	38 1/2	1	1	
66	58	73	69	47	47	70 1/4	66 3/4	73 1/2	42 5/8	70	56	72 5/8	7	10 1/2	73 1/2	49 1/2	49 1/2	59 1/2	72 1/2	27 1/4	29	42 1/4	1	1	
73	64	80 1/2	76	51 1/2	51 1/2	76 1/2	73 7/8	81 1/4	47 1/8	77 1/2	61 7/8	81 3/4	9	11	81 1/2	54 3/4	7	64 3/4	80	29 7/8	33 1/2	46 1/4	1	1	

* For TH, BH, UB, DB, BAU, and TAU discharges.

Tolerance: ± 1/8"

COMPLETE SELECTION OF AIR-MOVING EQUIPMENT

The New York Blower Company offers thousands of different types, models, and sizes of air-moving equipment. Contact your nyb representative for assistance in identifying the best fan for your application.

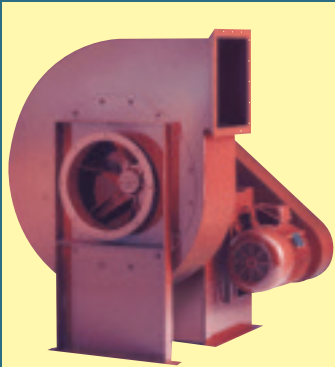

DUST/MATERIAL HANDLING

Wide range of duty available with unique fan lines capable of handling light dust to heavy material. Typical applications include dust-collection and high-pressure process along with material-conveying.



AIR-HANDLING [CENTRIFUGAL]

Designed for clean to moderately dirty gas streams. Commercial and industrial HVAC, process cooling, light material-conveying, heat removal, and dryer exhaust are just a few of the numerous sample applications



AIR-HANDLING [AXIAL]

For the ideal handling of clean to moderately dirty airstreams. Commercial and industrial HVAC, drying and cooling systems, fume extraction, and process-heat removal are typical applications.



FIBERGLASS REINFORCED PLASTIC [FRP]

Choice of performance and duty for corrosive gas streams. Applications include chemical process, wastewater treatment, laboratory hood exhaust, and tank aeration.

CUSTOM PRODUCTS

Designed for unique applications. Variety of configurations, temperatures, flows, and pressures. Wide range of modifications and accessories are available to meet the most demanding specifications.



Leading the industry forward since 1889



ROOF VENTILATORS

Including both hooded and upblast ventilators, propeller fans, and centrifugal roof exhausters. These units are ideal for industrial, commercial, and institutional applications.



HEATING PRODUCTS

Industrial-duty steam unit heaters with steam heating coils are available for facility heating and process-heat transfer.



PROCESS/FAN COMPONENTS

Plug fans, plenum fans, wheels, inlet cones, and housings for a wide variety of OEM applications. Process/fan components are used in air-handling units, ovens, dryers, freezer tunnels, and filtration systems.