

PRESSURE BLOWERS

- Capacities to 5,200 CFM
- Two wheel choices
- Static pressures to 58"WG
- Temperatures to 600°F.

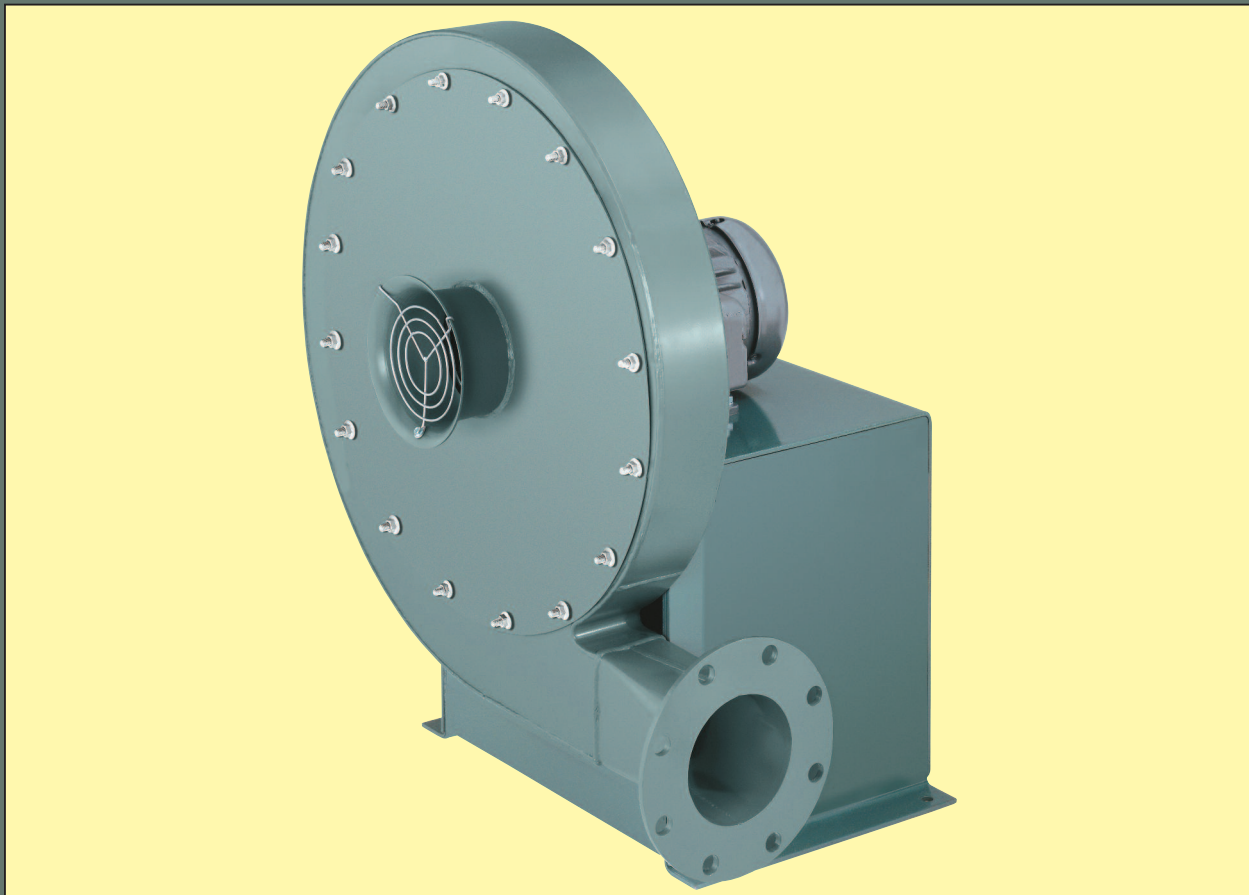

THE NEW YORK BLOWER COMPANY
7660 Quincy Street
Willowbrook, IL 60527-5530

Visit us on the Web: <http://www.nyb.com>
Phone: (800) 208-7918 Email: nyb@nyb.com

For greater
pressures and
capacities:
see Type HP
Pressure Blowers

PRESSURE BLOWERS

...for process systems

DESIGN FEATURES

- Pressures to 58" WG.
- Capacities to 5,200 CFM.
- Stable performance . . . the pressure curve remains stable from wide-open to closed-off . . . fan instability, or pulsation, is eliminated even when "turn-down" approaches zero flow.
- Choice of wheel designs . . . standard aluminum wheel for optimum efficiency or optional steel wheel for more rugged applications.
- Efficiency . . . advanced wheel and aerodynamic housing design combine for air-handling efficiency superior to conventional radial-wheel designs.
- Variable wheel diameters and a choice of six outlet sizes enable efficient fan selection across a wide range of volumes and pressures.
- Choice of arrangements . . . direct-drive and belt-drive.
- Wide application range . . . designed for continuous operation in combustion, cooling, conveying, drying, and various process systems.

CONSTRUCTION FEATURES

- All-welded steel housings . . . heavy-gauge housings are designed specifically to prevent "flexing" at high pressures.
- Flanges . . . continuously welded flanges match ANSI Class 125/150 hole pattern.
- Balance . . . all wheels are precision-balanced prior to assembly . . . fans with motors and drives mounted by **nyb** are given a final trim balance check at the specified running speed.
- Shafting . . . straightened to close tolerance to minimize "run-out" and ensure smooth operation.
- Inlet configuration . . . a choice of three inlet types allows units to be tailored to specific application requirements.
- Lifting eyes . . . standard on all units for ease of handling and installation.
- Finish . . . medium-green industrial coating.

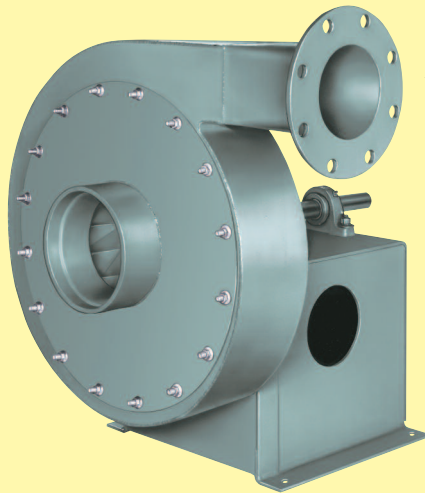

ARRANGEMENT

1

Pressure Blower with plain pipe inlet.

ARRANGEMENT

4

Pressure Blower with motor.

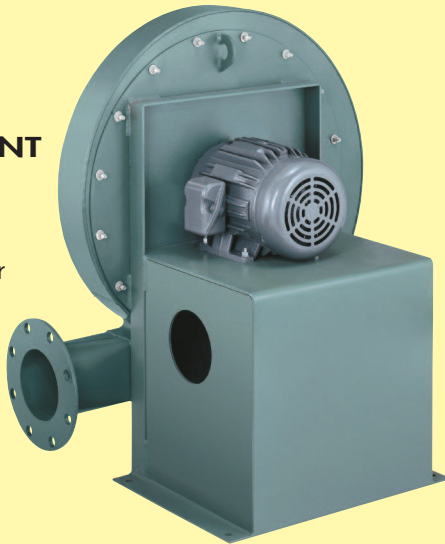

ARRANGEMENT

4-V

Pressure Blower with motor.

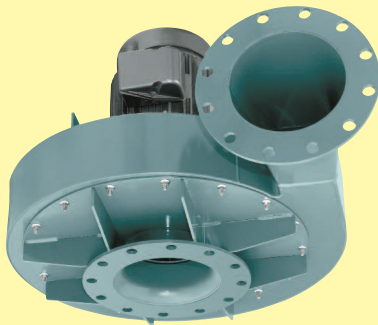

The New York Blower Company certifies that the Pressure Blowers shown herein are licensed to bear the AMCA Seal. The ratings shown are based on tests and procedures performed in accordance with AMCA Publication 211 and comply with the requirements of the AMCA Certified Ratings Program.

ACCESSORIES/MODIFICATIONS

- **COMPANION FLANGES**

Designed to fit flush with fan inlet and outlet flanges, provided with a matching hole pattern.

- **DRAINS**

Tank flange is welded to the lowest point of the housing scroll . . . female pipe thread.

- **INLET FILTER**

Filters are available with a choice of three element types: wire mesh, hi-flow polyester, and ultra-synthetic. High-efficiency filter is flange-mounted. Furnished standard with outboard support bracket and available with or without protective hood.

- **SILENCERS**

Available to match standard inlet or outlet flange sizes. Heavy-welded construction filled with high-density, acoustical absorption material.

- **OUTLET DAMPERS**

Available as either an integral outlet design for fixed damper control or as a separate wafer design for variable-flow applications [shown]. Wafer damper is available with an optional actuator and positioner.



- **SHAFT SEALS**

Ceramic-felt shaft seals consist of compressed ceramic felt elements. Lubricated lip seals [Buna, Teflon®, and Viton®] and gas-purgeable, segmental bushing seals are also available. See your **nyb** representative for availability.

[Teflon and Viton are registered trademarks of DuPont and DuPont Dow Elastomers, respectively.]

- **ACCESS DOOR**

Gasketed, flush-bolted door opens to provide access to the wheel.

- **HEAT-FAN CONSTRUCTION**

Available on Arrangements 1, 8, 9, and 10 steel wheel Pressure Blowers up to 600°F. Modifications include shaft cooler and shaft-cooler guard.

- **LL-1 LOW LEAKAGE CONSTRUCTION**

Special construction to minimize leakage includes lip-type shaft seal, non-rotatable housing with solid drive side, double studs, and neoprene gasketing. Maximum temperature 200°F. due to gasketing limitations. Not available with heat-fan construction. Contact your **nyb** representative for other options.

- **SPECIAL ALLOY CONSTRUCTION**

Airstream components can be constructed of a wide range of alternate alloys for corrosive applications.

- **UNITARY BASE**

Fan, motor, and guards can be mounted and shipped on a rugged, structural-steel base. Factory-assembled and run-tested prior to shipment.

ARRANGEMENT

8

Pressure Blower with Venturi inlet, shaft and bearing guard, coupling guard, and motor.

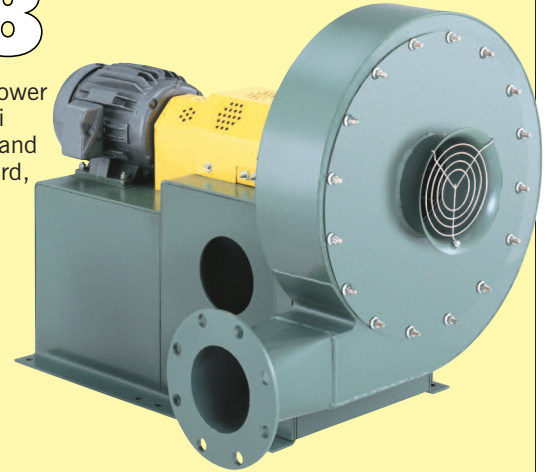

ARRANGEMENT

9

Pressure Blower with flanged inlet, flush-bolted cleanout door, motor, belt guard, and shaft and bearing guard.

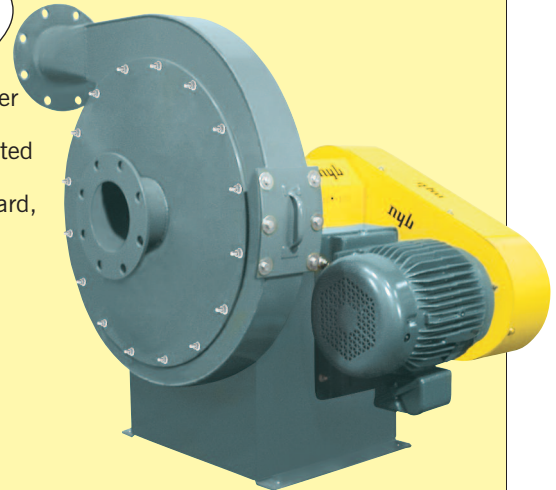

ARRANGEMENT

10

Pressure Blower with flanged inlet and optional weather cover/belt guard.

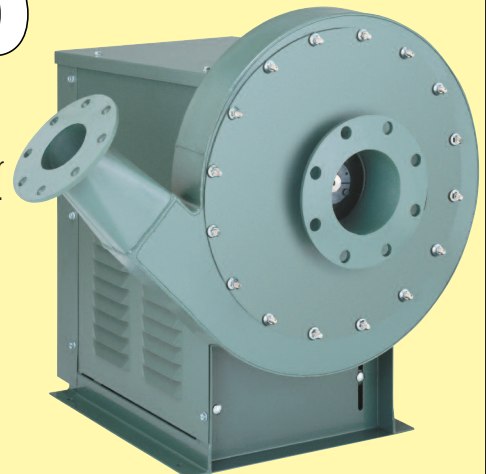

WHEELS

STANDARD ALUMINUM

The unique Aluminum Pressure Blower wheel is designed to provide efficient performance and reduced sound levels ... the dual-taper design concept on all but the narrowest wheel sizes yields typical efficiencies up to 10 percentage points greater than conventional straight radial wheels. Riveted high-strength aluminum alloy blades and side plates minimize overhung wheel weight and starting inertia. Ductile-iron, taper-lock hubs make wheels easily removable.

Note: Maximum operating temperature of aluminum wheel is 200°F.

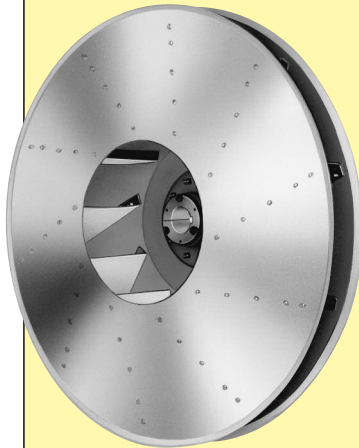

OPTIONAL STEEL

Either welded steel or stainless-steel wheel construction is available in straight radial design. AMCA Certified Ratings Seal applies to Pressure Blowers with aluminum-wheel design only. Air volume and pressure capabilities are the same as the dual-taper aluminum wheel, but brake horsepower requirements are typically higher. Refer to The New York Blower Company's fan-selection program for details.

Note: Maximum operating temperature of steel wheel with heat fan construction is 600°F. Some fan-and-motor combinations with steel wheels may be restricted due to starting torque requirements. Consult **nyb**.

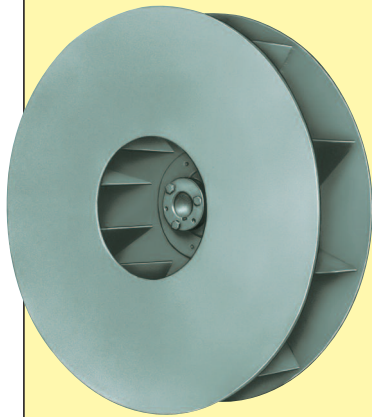

CHART I MAXIMUM SAFE SPEEDS [RPM]†

Wheel diameter	Aluminum wheel	Steel wheel	
	All Arr.	Arr. 1, 4, 4-V, 8, 9	Arr. 10
14	4000	4000	4000
15	4000	4000	4000
16	4000	4000	4000
17	4000	4000	4000
18	4000	4000	4000
19	3900	3900	2992
20	3900	3900	2918
21	3900	3900	2851
22	3900	3900	2787
23	3800	3800	3178
24	3800	3800	3121
25	3800	3800	3068
26	3800	3800	3017

† derate for temperature not required.

* Arr. 9 fans may have additional speed limits based on pedestal length.

CHART II

STEEL WHEEL HORSEPOWER CORRECTIONS

18" Pressure Blower with 04 outlet to handle 400 CFM at 23½"SP at .075 lbs./ft.³ density. Aluminum wheels require 2.6 BHP as shown on page 7. Steel or stainless-steel wheels require [1.15 x 2.6] 3.0 BHP.

Outlet size	Wheel size	BHP correction factors
03	14 to 22	0.96
	23 to 26	1.02
04	14 to 26	1.15
06	14 to 18	1.06
	19 to 26	1.15
08	15 to 22	1.06
	23 to 26	1.15
10	19 to 26	1.06
12	19 to 26	1.06

SPARK-RESISTANT CONSTRUCTION [SRC]

Intended to minimize the potential for any two or more fan components to generate sparks within the airstream by rubbing or striking during operation.

The following types are available:

AMCA A [AIRSTREAM] SRC

To include all airstream parts constructed of a spark-resistant alloy . . . maximum temperature: 200°F.

AMCA B [WHEEL] SRC

To include the fan wheel constructed of a spark-resistant alloy and a buffer plate around the housing shaft-hole opening . . . maximum temperature: 200°F.

SAFETY EQUIPMENT

Safety accessories are available from **nyb**, but selection of the appropriate devices is the responsibility of the system-designer who is familiar with the particular installation, or application, and can provide for guards for all exposed moving parts as well as protection from access to high-velocity airstreams. Neither **nyb** nor its sales representatives is in a position to make such a determination. Users and/or installers should read "Recommended Safety Practices for Air Moving Devices" as published by the Air Movement and Control Association International, Arlington Heights, Illinois.

PERFORMANCE

USING PERFORMANCE CURVES

Performance is shown according to outlet sizes for quick reference to duct diameter. Brake horsepower increments are identified on each curve. Recommended standard blower size and motor combinations, which are based on the most efficient area of operation, are listed on page 14 for Arrangements 4, 4-V, and 8. Nonstandard combinations are generally available, but are usually less efficient than the standard combinations.

SIZING NOMENCLATURE

7-digit model number designates the wheel diameter, outlet size, wheel type, and nominal motor horsepower.

Note: the last two digits showing motor horsepower are not required for Arrangement 1 Pressure Blowers.

EXAMPLE

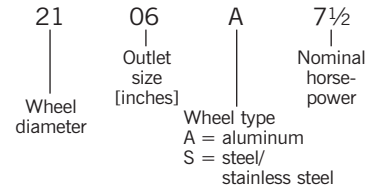

PROCEDURE	STEPS	EXAMPLE
Determine the appropriate outlet size.	1	The 06 outlet is selected for 800 CFM at 32"SP.
Plot the CFM and SP [standard] and select a performance curve for the fan size that meets or slightly exceeds the required performance.	2	A Size 2106A will provide 800 CFM at 33.6"SP.
Determine the BHP required for the point of operation . . . see page 4 for steel or stainless-steel wheel factors.	3	2106A requires 6.3 BHP. 2106S requires 7.2 BHP [6.3 x 1.15].
Read to the right to select motor horsepower.	4	A 7½ HP motor will cover both wheel types.

Note: The horsepower coverage of a given motor will increase 15% when a 1.15 service factor motor is utilized.

CORRECTION FACTORS

Performance is based on actual cubic feet per minute [ACFM] at the blower inlet at standard density [.075 lbs./ft.³] and static pressure at the blower outlet. Static pressure capabilities are shown in inches water gauge ["WG].

Air density corrections are necessary for proper selection when air density varies from the standard .075 lbs./ft.³ at 70°F. at sea level. This also occurs when negative static pressure exists [rarefaction] on the inlet side of the fan. Multiply the required static pressure at conditions by the appropriate factors in Charts III, IV, and V to obtain corrected pressure for blower selection. Pressure and BHP will be reduced at conditions by the inverse of these factors. Multiply one factor by the other if temperature, altitude, and rarefaction are non-standard. For example: If the installation is located at an altitude of 4000 feet, the gas temperature is 300°F., and the inlet pressure is -40"WG, the correction factor is 1.84 [1.16 x 1.43 x 1.11].

CHART III ALTITUDE [ft.] CORRECTIONS

Alt.	Factor
0	1.00
500	1.02
1000	1.04
1500	1.06
2000	1.08
2500	1.10
3000	1.12
3500	1.14
4000	1.16
4500	1.18
5000	1.20
6000	1.25
7000	1.30
8000	1.35
9000	1.40
10000	1.45

CHART IV TEMPERATURE CORRECTIONS

Temp. °F.	Factor
0	.87
20	.91
40	.94
60	.98
70	1.00
80	1.02
100	1.06
120	1.09
140	1.13
160	1.17
180	1.21
200	1.25
300	1.43
400	1.62
500	1.81
600	2.00

CHART V RAREFACTION CORRECTIONS

Neg. inlet pressure "WG	Factor
15	1.04
20	1.05
25	1.07
30	1.08
35	1.09
40	1.11
45	1.12
50	1.14
55	1.16
60	1.17
65	1.19
70	1.21
75	1.23
85	1.26

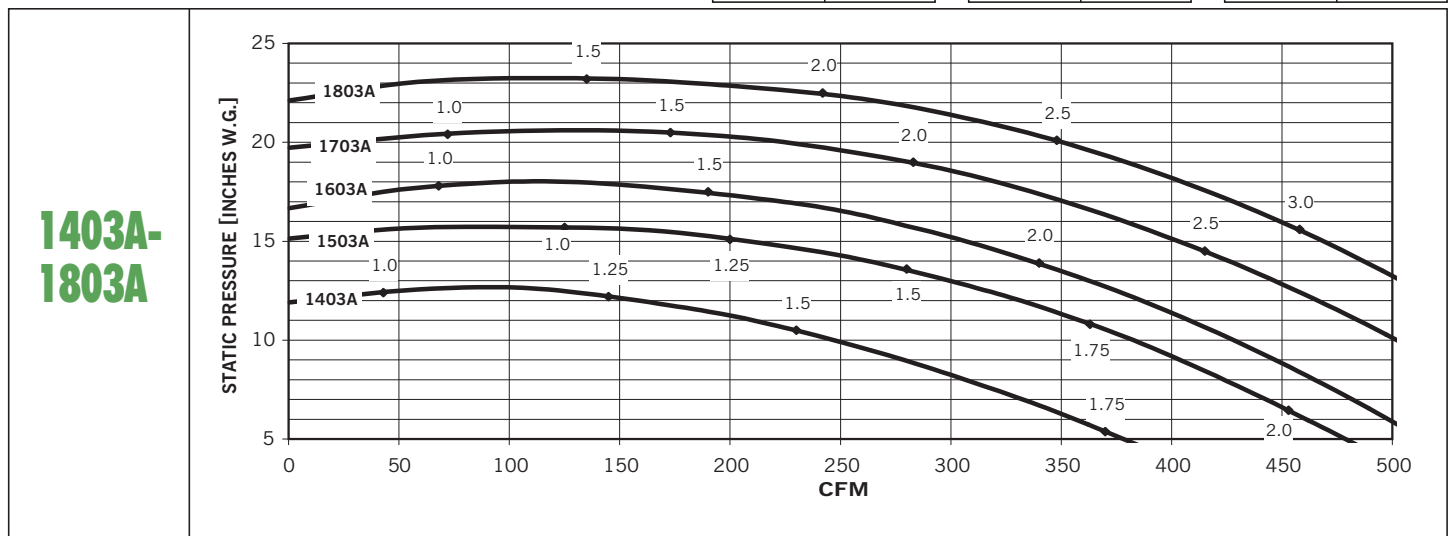

PERFORMANCE AT 3500 RPM

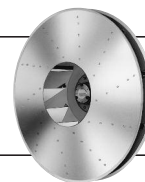

Aluminum Wheel
Pressure Blower

NOTE: Values shown on curves indicate brake horsepower [BHP] required.

**1903A-
2203A**

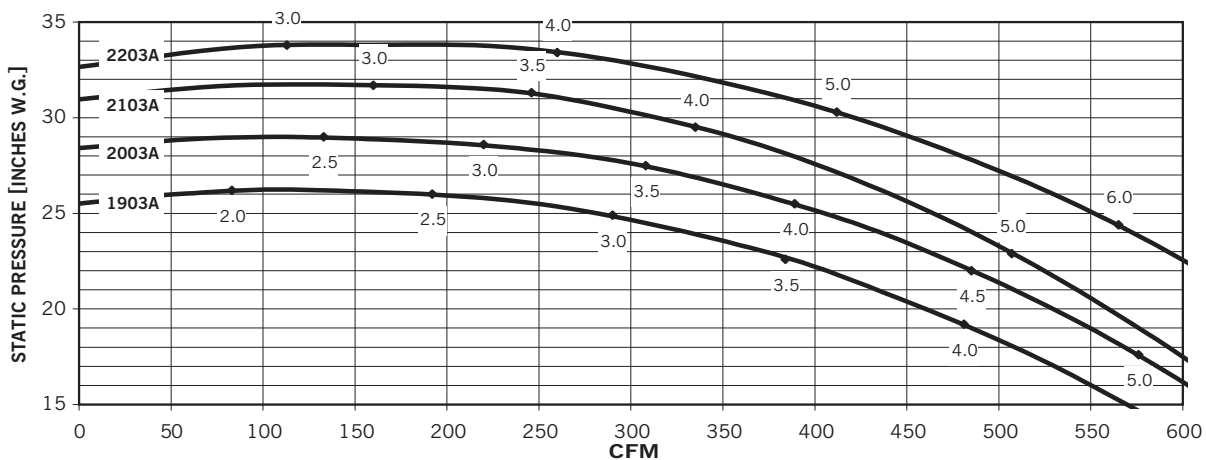

**2303A-
2603A**

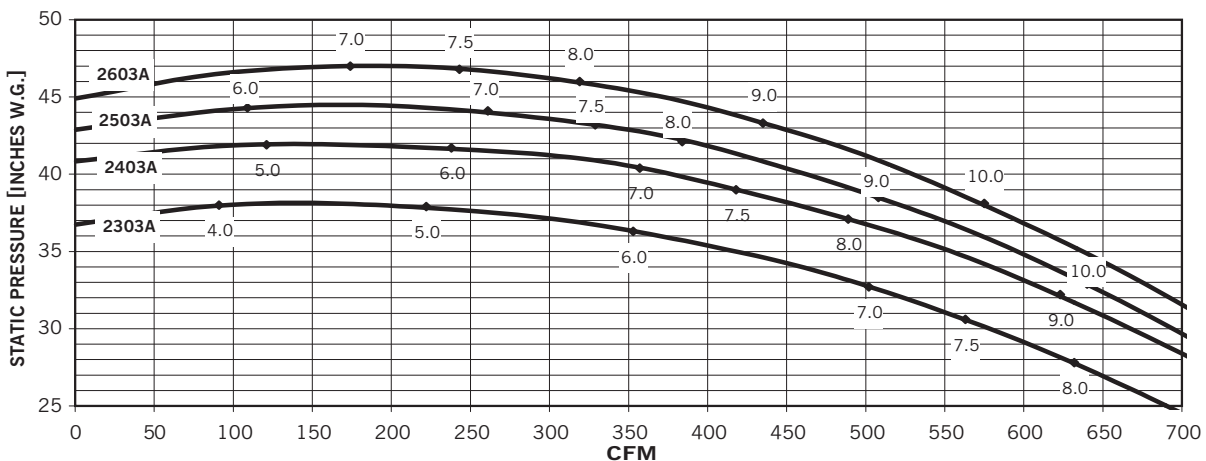

**1404A-
1804A**

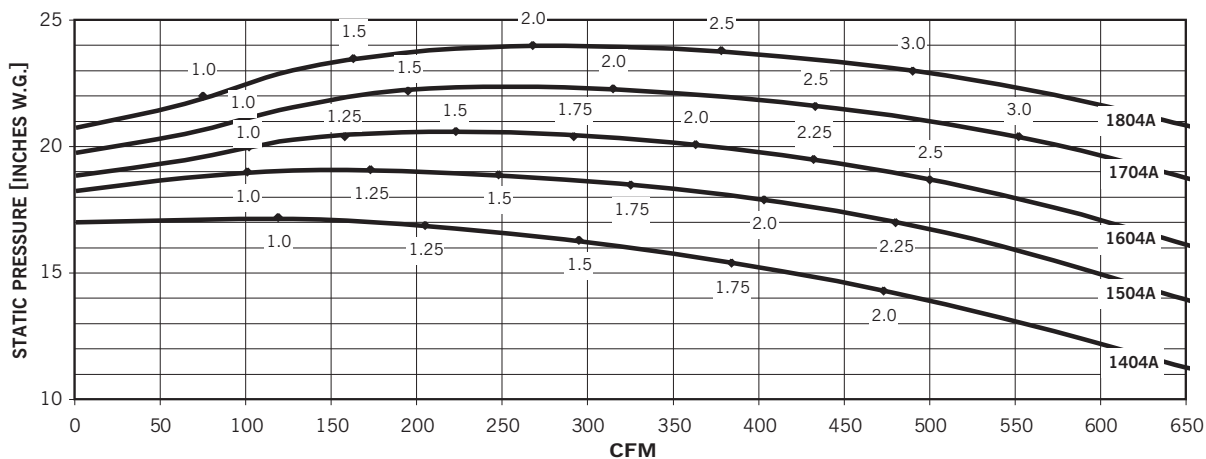

Performance certified is installation Type B: Free inlet, Ducted outlet. Power rating (BHP) does not include transmission losses. Performance ratings do not include the effects of appurtenances (accessories).

PERFORMANCE AT 3500 RPM

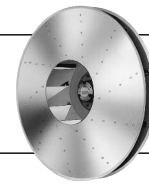

Aluminum Wheel
Pressure Blower

NOTE: Values shown on curves indicate brake horsepower [BHP] required.

**1904A-
2204A**

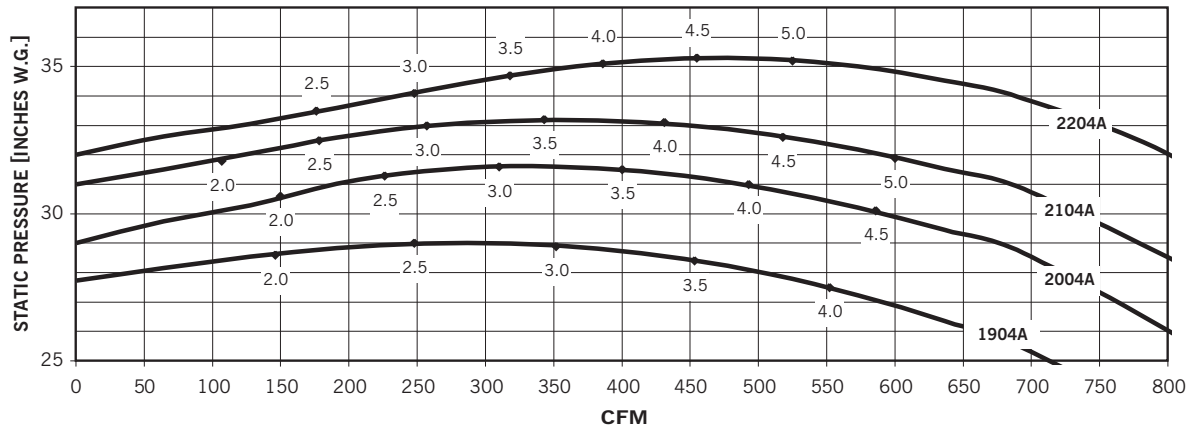

**2304A-
2604A**

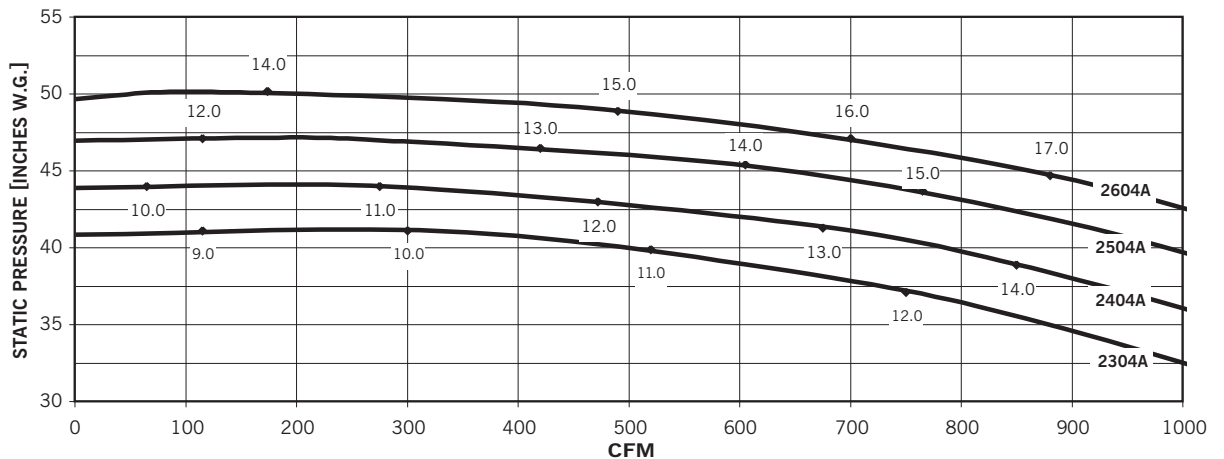

**1406A-
1806A**

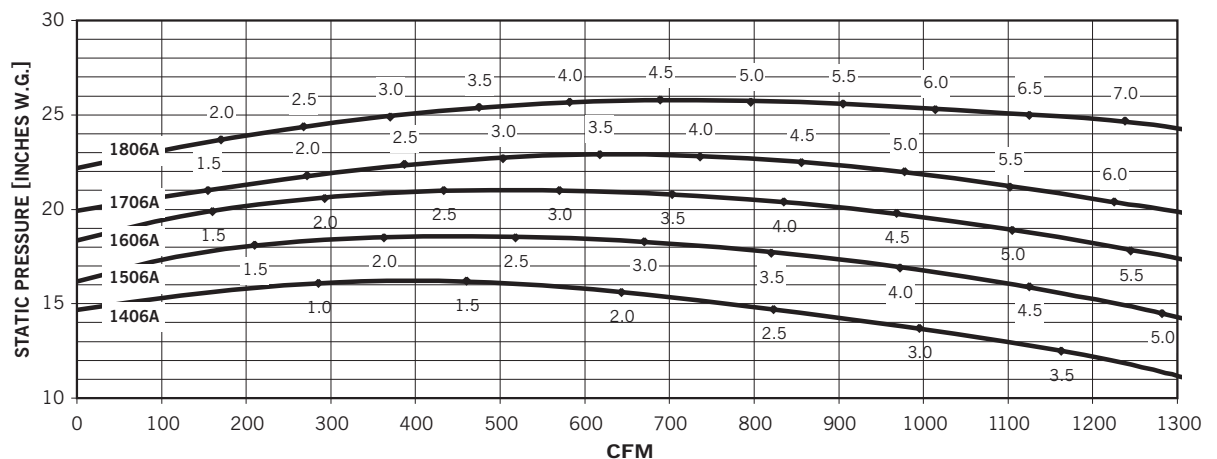

Performance certified is installation Type B: Free inlet, Ducted outlet. Power rating (BHP) does not include transmission losses. Performance ratings do not include the effects of appurtenances (accessories).

PERFORMANCE AT 3500 RPM

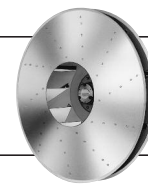

Aluminum Wheel
Pressure Blower

NOTE: Values shown on curves indicate brake horsepower [BHP] required.

**1906A-
2206A**

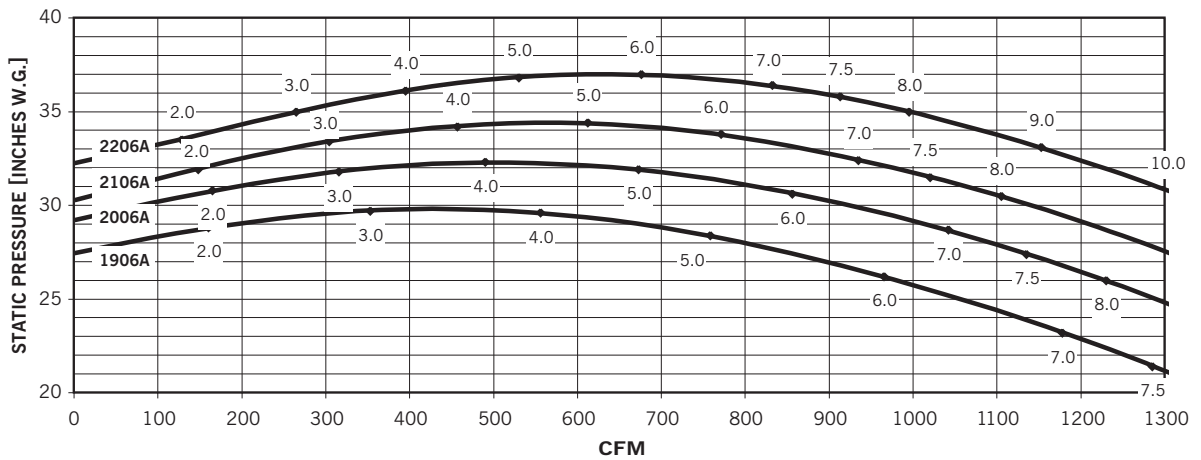

**2306A-
2606A**

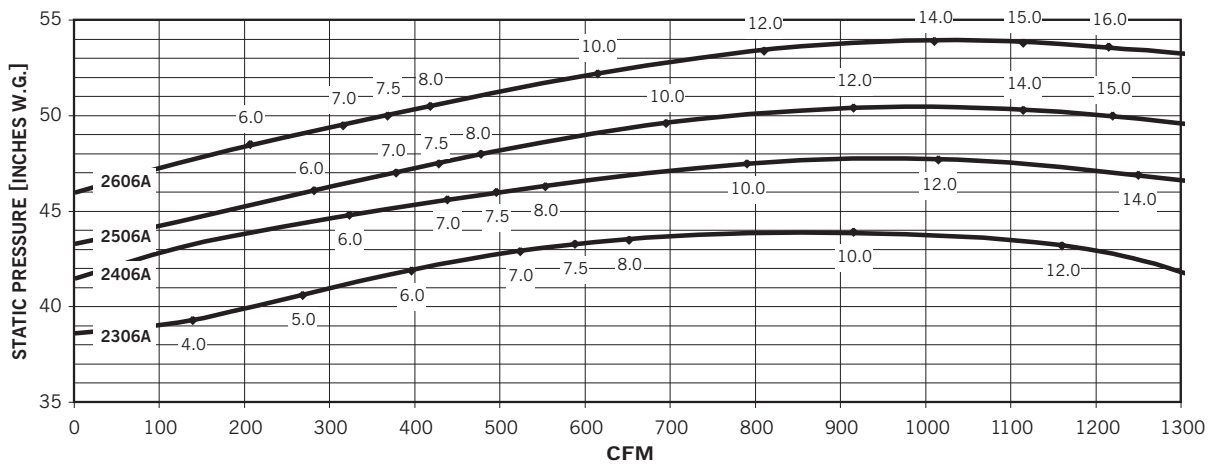

**1508A-
1808A**

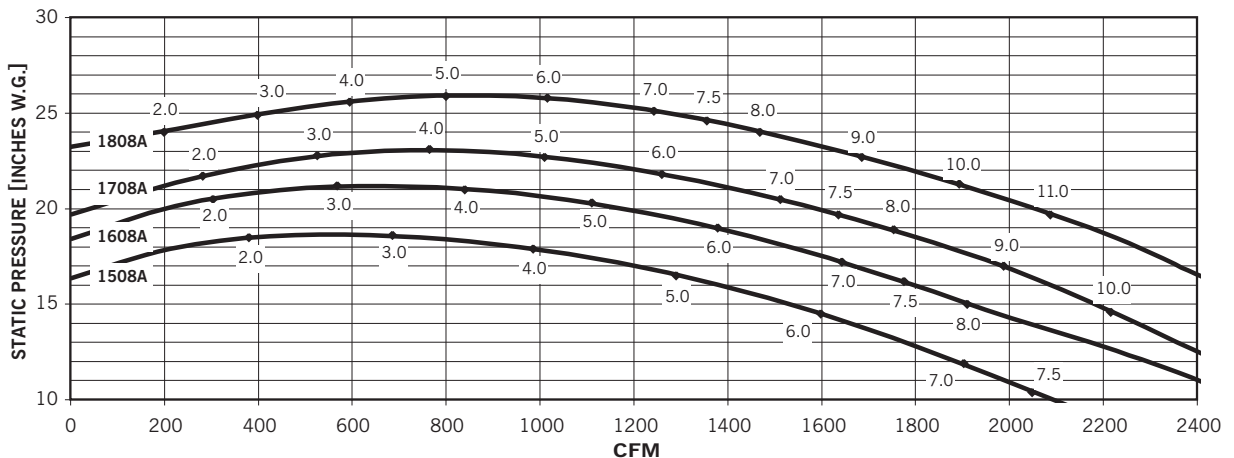

Performance certified is installation Type B: Free inlet, Ducted outlet. Power rating (BHP) does not include transmission losses. Performance ratings do not include the effects of appurtenances (accessories).

PERFORMANCE AT 3500 RPM

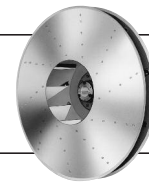

Aluminum Wheel
Pressure Blower

NOTE: Values shown on curves indicate brake horsepower [BHP] required.

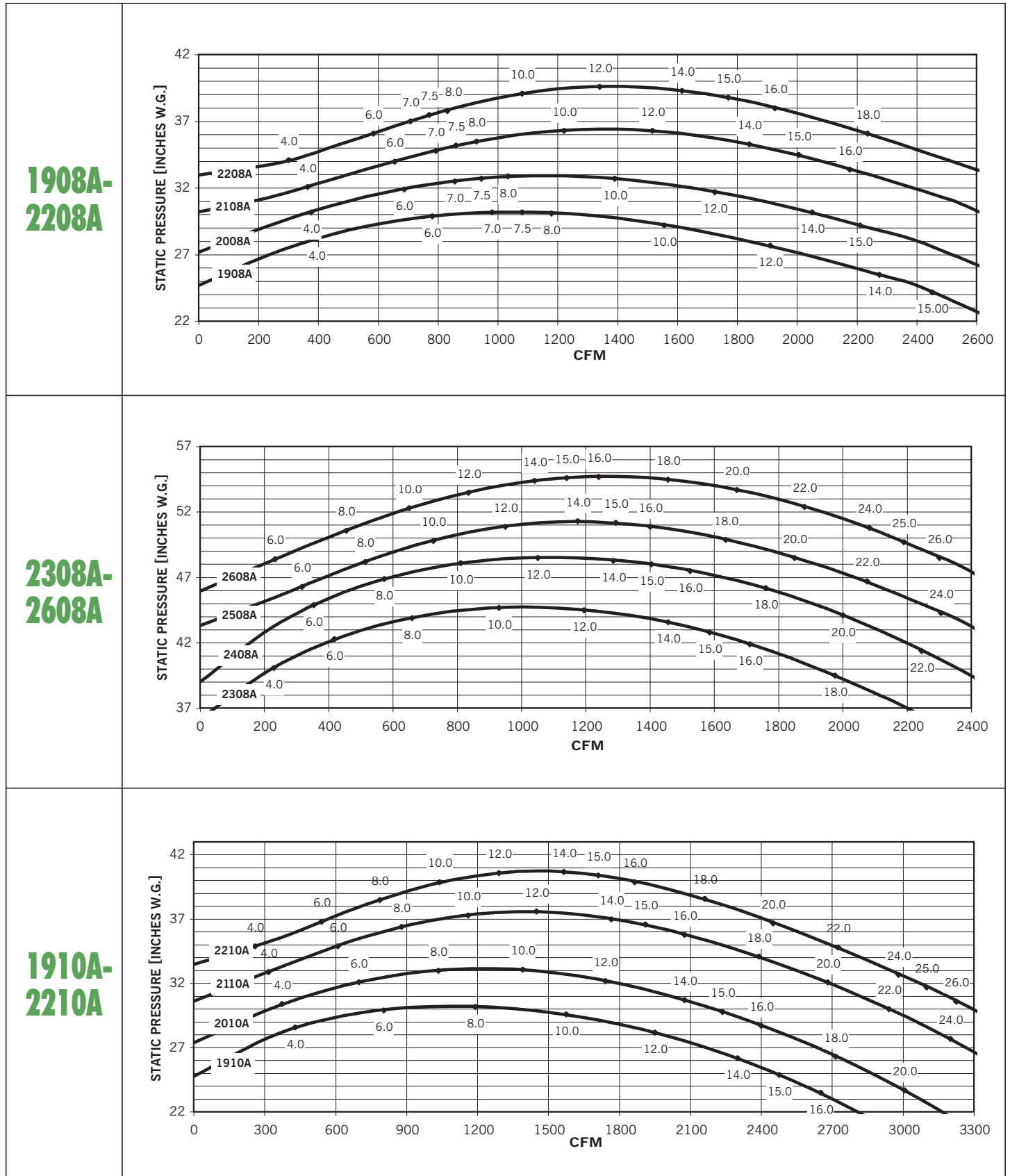

Performance certified is installation Type B: Free inlet, Ducted outlet. Power rating (BHP) does not include transmission losses. Performance ratings do not include the effects of appurtenances (accessories).

PERFORMANCE AT 3500/3550 RPM

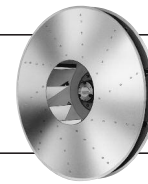

Aluminum Wheel
Pressure Blower

NOTE: Values shown on curves indicate brake horsepower [BHP] required.

**2310A-
2610A**

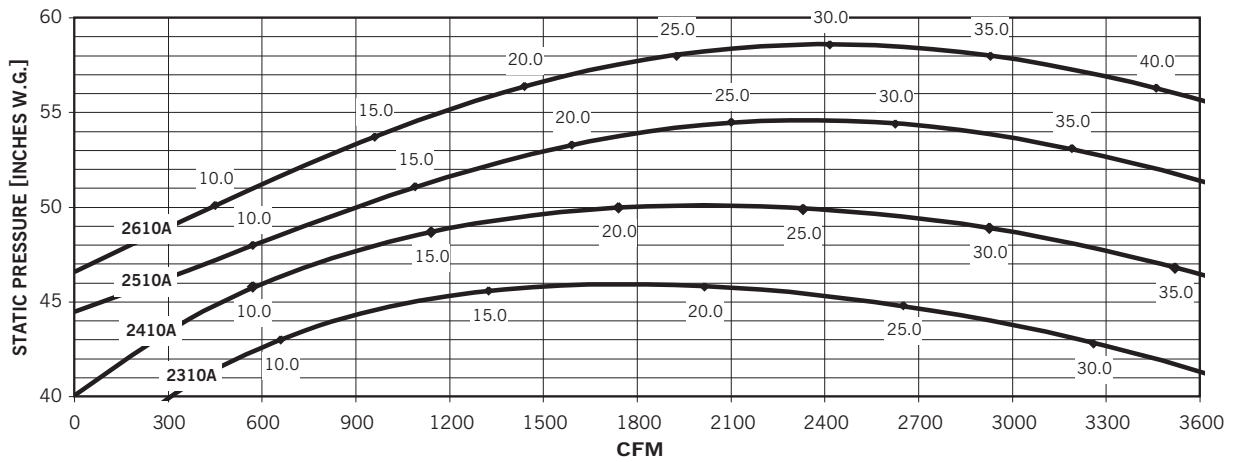

**1912A-
2212A**

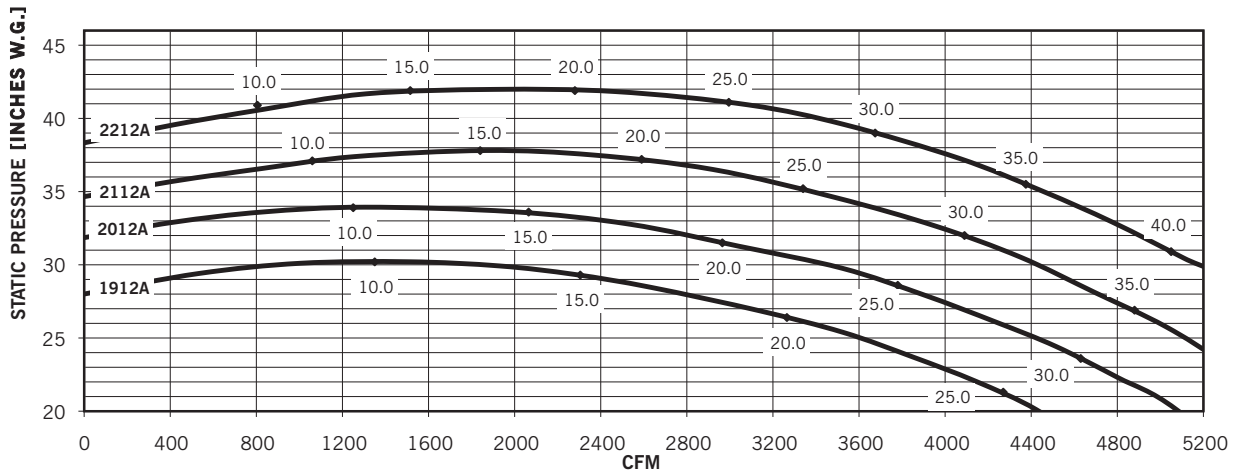

**2312A-
2612A**

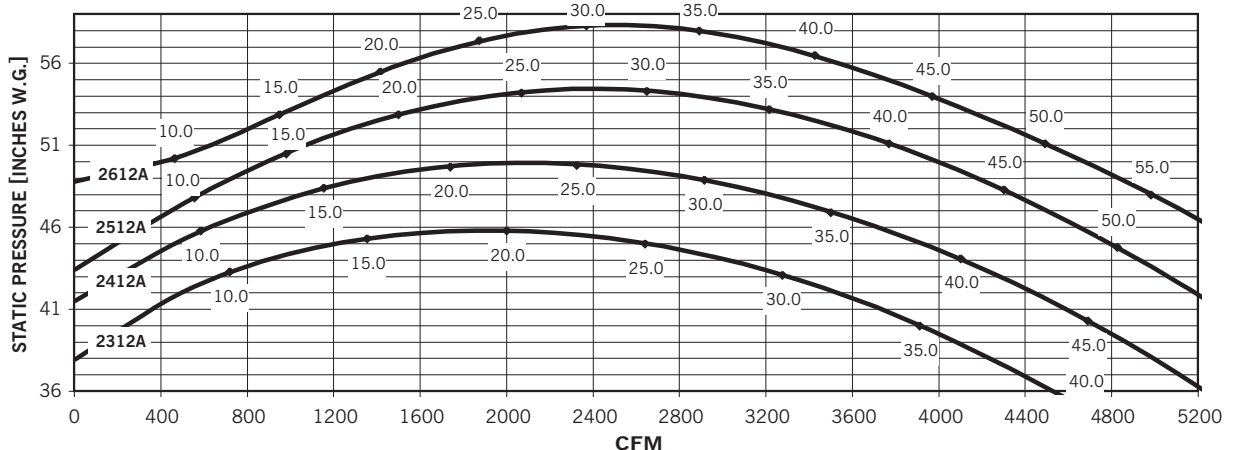

Performance certified is installation Type B: Free inlet, Ducted outlet. Power rating (BHP) does not include transmission losses. Performance ratings do not include the effects of appurtenances (accessories).

SPECIFICATIONS

U.S. standard sheet gauge to 7 gauge. Dimensions in inches. Weights in pounds. WR² in lb.-ft.².

WHEEL SPECIFICATIONS

Size	Aluminum		Steel	
	Wt.	WR ²	Wt.	WR ²
1403	10.1	0.96	19.7	2.74
1404	8.5	1.43	18.0	3.04
1406	11.7	2.40	20.5	3.46
1503	10.8	1.23	21.8	3.59
1504	8.8	1.69	19.0	3.68
1506, 1508	11.8	2.40	21.5	4.16
1603	11.5	1.53	23.9	4.56
1604	9.0	1.98	20.0	4.41
1606, 1608	12.1	2.50	23.0	5.07
1703	12.3	1.93	26.3	5.79
1704	9.3	2.30	21.0	5.22
1706, 1708	12.2	2.60	24.5	6.09
1803	13.0	2.36	28.6	7.16
1804	9.5	2.65	22.0	6.13
1806, 1808	12.4	2.60	26.0	7.25
1903	14.2	2.92	31.1	8.42
1904, 1906	12.0	3.73	29.5	9.16
1908, 1910	15.1	5.10	34.5	10.72
1912	12.9	5.07	32.8	10.15
2003	15.1	5.02	33.7	10.23
2004, 2006	12.3	4.22	31.0	10.67
2008, 2010	15.3	5.20	36.5	12.56
2012	13.1	5.21	36.1	12.37
2103	16.0	4.24	36.5	12.31
2104, 2106	12.5	4.74	32.5	12.33
2108, 2110	15.5	5.30	38.0	14.42
2112	13.3	5.34	39.4	14.91
2203	17.1	5.02	39.3	14.70
2204, 2206	12.8	5.31	34.0	14.16
2208, 2210	15.6	5.40	40.0	16.66
2212	13.5	5.48	42.9	17.80
2303	18.3	6.07	49.4	20.83
2304	19.8	6.50	52.5	22.27
2306, 2308	18.5	8.42	45.0	20.93
2310, 2312	21.7	10.60	53.5	24.35
2403	19.4	7.16	53.1	24.50
2404	20.9	7.80	56.4	26.14
2406, 2408	18.8	9.29	48.0	23.79
2410, 2412	21.9	10.80	56.0	27.75
2503	20.5	8.33	56.9	28.64
2504	22.0	9.00	60.4	30.49
2506, 2508	19.0	10.22	50.0	26.89
2510, 2512	21.9	11.00	58.5	31.46
2603	21.8	9.63	60.9	33.27
2604	23.1	10.30	64.5	35.36
2606, 2608	19.3	11.20	52.0	30.24
2610, 2612	22.3	11.20	61.0	35.48

MATERIAL SPECIFICATIONS

HOUSING				
Wheel diameter	Sides	Scroll	Inlet plate	Drive plate
14-18	10	10	1/4	10
19-22	10	10	1/4	10
23-26	10	10	1/4	10

SHAFT DIAMETER				
Wheel diameter	Arrangement 1		Arrangement 8	
	Standard	Heat Fan with Shaft Seal	Standard	Heat Fan with Shaft Seal
14-18	1 ⁷ / ₁₆	1 ⁷ / ₁₆	1 ⁷ / ₁₆	1 ⁷ / ₁₆
19-22	1 ⁷ / ₁₆	1 ¹¹ / ₁₆	1 ⁷ / ₁₆	1 ⁷ / ₁₆
23-26	1 ¹¹ / ₁₆	1 ¹⁵ / ₁₆ †	1 ⁷ / ₁₆	1 ¹¹ / ₁₆

SHAFT DIAMETER				
Wheel diameter	Arrangement 9		Arrangement 10	
	Standard	Heat Fan with Shaft Seal	Standard	Heat Fan
14-18	1 ⁷ / ₁₆	1 ⁷ / ₁₆	1 ⁷ / ₁₆	1 ⁷ / ₁₆
19-22	1 ¹¹ / ₁₆	1 ¹¹ / ₁₆	1 ⁷ / ₁₆	1 ⁷ / ₁₆
23-26	1 ¹⁵ / ₁₆	1 ¹⁵ / ₁₆	1 ¹¹ / ₁₆	1 ¹¹ / ₁₆

BEARINGS*				
Wheel diameter	Arrangement 1/9		Arrangement 8	Arrangement 10
	Inboard	Outboard		
14-18	A	A‡	A	A
19-22	B	B	A	B
23-26	C	B‡	A	B

A-200 Series ball bearing. B-22400 Series roller bearing.
C-300 Series ball bearing.

*nyb reserves the right to substitute bearings of equal rating.

‡ Fans with heat fan construction and shaft seal:

Arr. 1: Sizes 23-26 include a shaft turndown at the outboard bearing, with a bearing size of 1¹¹/₁₆". Inboard bearing size is 1¹⁵/₁₆".

Arr. 9: Sizes 14-18 include a Type B outboard bearing, in lieu of the standard Type

FLANGE				
DIMENSIONS [INCHES]				
Size	I.D.	O.D.	Bolt circle	Holes† No. - size
03	3	7 ¹ / ₂	6	4 - 3/4"
04	4	9	7 ¹ / ₂	8 - 3/4"
05	5	10	8 ¹ / ₂	8 - 7/8"
06	6	11	9 ¹ / ₂	8 - 7/8"
08	8	13 ¹ / ₂	11 ³ / ₄	8 - 7/8"
10	10	16	14 ¹ / ₄	12 - 1"
12	12	19	17	12 - 1"

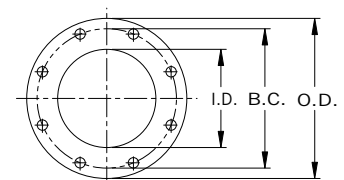

† Holes straddle centerline. ANSI Class 125/150 hole pattern. Flange thickness 3/8"

ARRANGEMENTS

1/9

PRESSURE BLOWERS

Maximum Airstream Temperature:
 200°F. – aluminum wheel.
 300°F. – steel wheel.
 600°F. – heat fan.

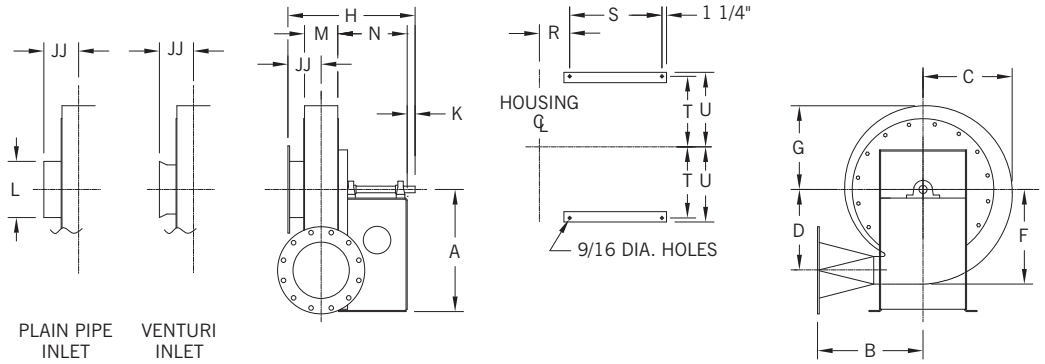

ARRANGEMENT

4

PRESSURE BLOWERS

Maximum Airstream Temperature:
 180°F.

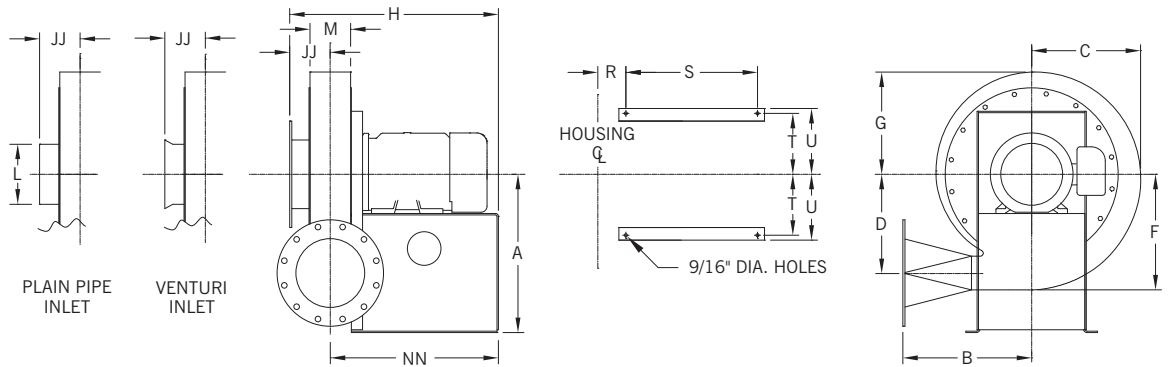

ARRANGEMENT

4-V

PRESSURE BLOWERS

Maximum Airstream Temperature:
 120°F.

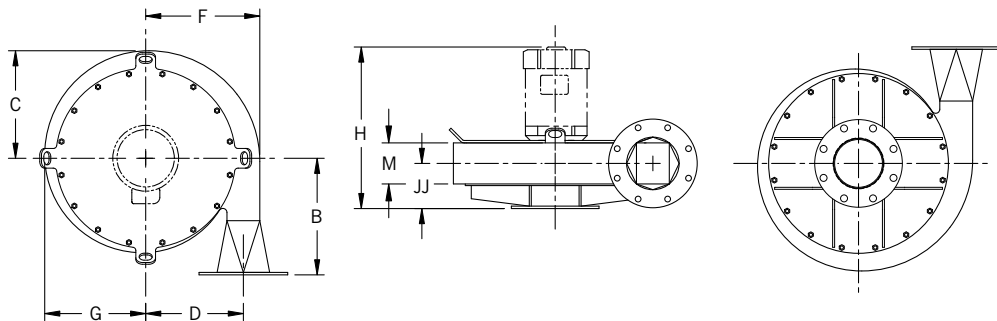

ARRANGEMENT

8

PRESSURE BLOWERS

Maximum Airstream Temperature:
 200°F. – aluminum wheel.
 300°F. – steel wheel.
 600°F. – heat fan.

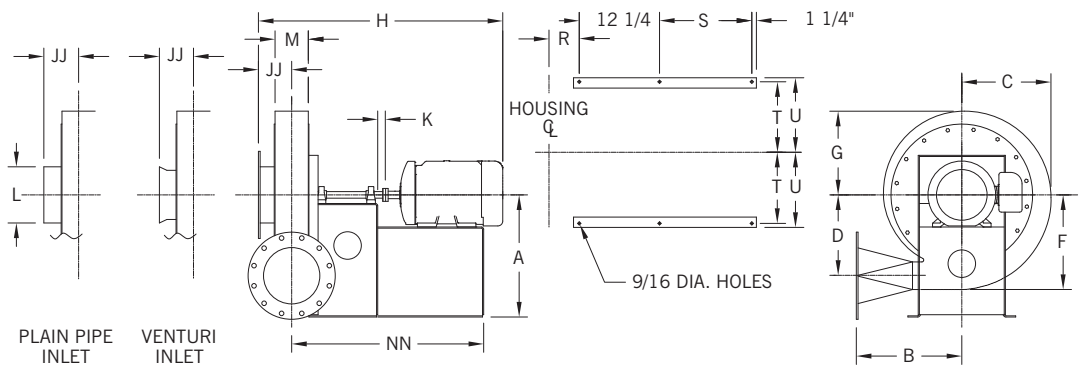

ARRANGEMENT

10

PRESSURE BLOWERS

Maximum Airstream Temperature:
 200°F. – aluminum wheel.
 300°F. – steel wheel.
 600°F. – heat fan.

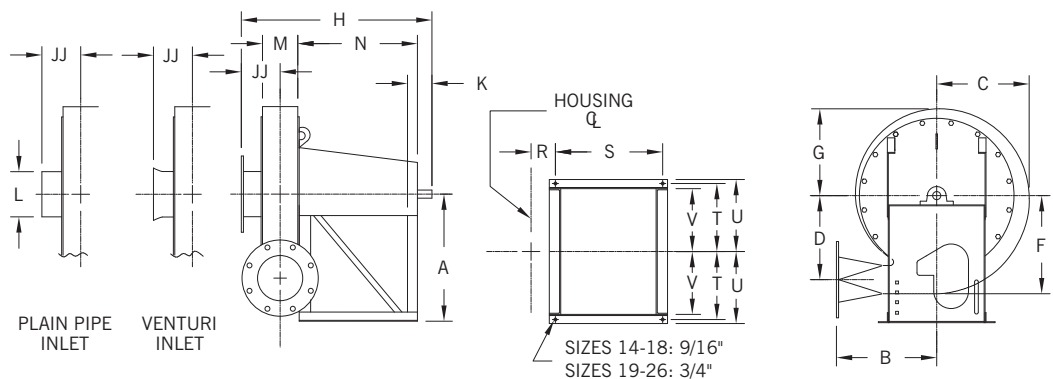

ARRANGEMENTS 1, 4, 4-V, 8, 9, 10

Dimensions not to be used for construction unless certified. Bare fan weight does not include wheel or motor. Weights in pounds. Wheel weights on page 11.

HOUSING DIMENSIONS [INCHES]

Fan Size	Outlet Size	Inlet Size	B	C	D	F	G	M	JJ [Inlet types]			L
									Flanged	Plain pipe	Venturi	
14-18	03	05	18 ¹ / ₄	13 ⁵ / ₈	11 ³ / ₄	14 ³ / ₈	12 ³ / ₄	27/8	5 ¹ / ₁₆	4 ¹¹ / ₁₆	49/16	59/16
	04	06						37/8	59/16	53/16	413/16	65/8
	06	08						6 ¹ / ₄	6 ³ / ₄	6 ³ / ₈	6 ³ / ₈	8 ⁵ / ₈
	08	08										
19-22	03	05	17 ³ / ₄	16 ¹ / ₂	147/8	17 ¹ / ₂	15 ¹ / ₂	27/8	59/16	53/16	53/16	59/16
	04	06						37/8	6 ¹ / ₁₆	5 ¹¹ / ₁₆	55/16	65/8
	06	06						6 ¹ / ₄	6 ³ / ₄	6 ³ / ₈	6 ³ / ₈	8 ⁵ / ₈
	08	08										
	10	10	21 ³ / ₄									
12	12	23		14 ¹ / ₂			7 ¹ / ₄	7 ¹ / ₄	67/8	67/8	10 ³ / ₄	
23-26	03	05	19	19 ¹ / ₂	17 ⁵ / ₈	20 ⁵ / ₈	18 ¹ / ₄	35/8	6 ⁵ / ₁₆	5 ¹⁵ / ₁₆	59/16	59/16
	04	06						5	7	6 ⁵ / ₈	6 ⁵ / ₈	6 ⁵ / ₈
	06	08										
	08	08										
	10	10	23					7 ¹ / ₄	7 ¹ / ₄	67/8	67/8	10 ³ / ₄
12	12											

BARE FAN WEIGHTS AND MOTOR LIMITATIONS

Tolerance: ± 1/8"

Fan Size	Outlet Size	Inlet Size	Arr. 1 Wt.	Motor Frame Size (Arr. 4, 8)	Weight		Motor Frame Size	Weight	Fan Size	Outlet Size	Arr. 9		Arr. 10													
					Arr. 4	Arr. 8					Pedestal Number	Weight	Weight	Max. Motor Size												
													ODP	TEFC	C-NW											
14-18	03	05	200	143T-145T	145	285	182TC-184TC	120	14-18	03	1	190	220	215T	215T	16 ⁵ / ₈										
				182T-184T	170			2			225															
	04	06	205	143T-145T	150	295	182TC-184TC	130			3	260														
				182T-184T	175			4			300															
15-18	06	08	220	143T-145T	165	300	182TC-184TC	135	14-18	04	1	195	230	215T	215T	16 ⁵ / ₈										
				182T-184T	190			2			235															
				213T-215T	305	213TC-215TC	145	3			265															
19-22	08	08	220	182T-184T	190	310	182TC-184TC	145	19-22	06,08	4	305	245	256T	254T	18 ⁵ / ₈										
				213T-215T	315	213TC-215TC	160	1			210															
								2			250															
	03	05	270	143T-145T	235	370	182TC-184TC	160		19-22	03	3	280				290	256T	254T	18 ⁵ / ₈						
				182T-184T	375	182TC-184TC	170	4				325														
				213T-215T	380	213TC-215TC	175	5				280														
	04	06	275	143T-145T	245	385	182TC-184TC	170		19-22	03	6	300				290				256T	254T	18 ⁵ / ₈			
				182T-184T	385	182TC-184TC	175	7				340														
				213T-215T	390	213TC-215TC	190	8				360														
	06	06	275	143T-145T	245	390	182TC-184TC	175		19-22	03	9	370				305							256T	254T	18 ⁵ / ₈
				182T-184T	395	213TC-215TC	190	5				295														
				213T-215T	410	182TC-184TC	190	6				315														
08	08	290	182T-184T	260	415	213TC-215TC	190	19-22	04,06	7	355	305	256T	254T	18 ⁵ / ₈											
			213T-215T	290	430	254TC-256TC	190			8	375															
			254T-256T	270	415	213TC-215TC	190			9	385															
10	10	300	254T-256T	300	430	254TC-256TC	190	19-22	04,06	5	315	325				256T	254T	18 ⁵ / ₈								
			284TS-286TS	320	455	284TSC-286TSC	215			6	335															
							7			375																
12	12	320	254T-256T	320	455	284TSC-286TSC	215	19-22	08,10	8	395	350							256T	254T	18 ⁵ / ₈					
			284T-286T	345	460	324TSC-326TSC	205			9	405															
			324TS-326TS	445	254TC-256TC	205	5			340																
23-26	03	05	330	182T-184T	270	435	182TC-184TC	205	23-26	12	6	360										350	256T	254T	18 ⁵ / ₈	
				213T-215T	300	460	254TC-256TC	230			7	405														
				254T-256T	275	470	213TC-215TC	230			8	420														
	04	06	350	182T-184T	285	460	182TC-184TC	230		23-26	03,04	9	430	355	256T							254T				18 ⁵ / ₈
				213T-215T	315	485	254TC-256TC	230				10	435													
				254T-256T	290	475	213TC-215TC	230				11	455													
06	08	365	182T-184T	285	460	182TC-184TC	230	23-26	03,04	12	465	360	256T	254T		18 ⁵ / ₈										
			213T-215T	315	485	254TC-256TC	235			13	550															
			254T-256T	290	475	213TC-215TC	235			10	440															
08	08	365	254T-256T	320	495	254TC-256TC	235	23-26	06,08	11	460	375					256T	254T	18 ⁵ / ₈							
			284TS-286TS	320	495	284TSC-286TSC	255			12	470															
							13			555																
10	10	385	254T-256T	335	500	254TC-256TC	255	23-26	10,12	10	460	375								256T	254T		18 ⁵ / ₈			
			284TS-286TS	360	505	324TSC-326TSC	265			11	480															
			324TS-326TS	345	515	284TSC-286TSC	265			12	490															
12	12	395	284TS-286TS	345	515	284TSC-286TSC	265	23-26	10,12	13	570	375			256T							254T		18 ⁵ / ₈		
			324TS-326TS	370	520	324TSC-326TSC	265																			

N/A: Not Available due to motor shaft/wheel fit.

Tolerance: ± 1/8"

ARRANGEMENTS 4, 4-V, 8

Dimensions not to be used for construction unless certified. Note: See page 12 for dimensional drawings.

Wheel dia.	Outlet Size	Inlet flange	Arr. 4 & 8 Motor Frame Size	A		H*		Arr. 4-V Motor Frame Size	H*		K	NN		R	S		T		U			
				Arr. 4	Arr. 8†	Arr. 4	Arr. 8		Arr. 4-V	Arr. 8		Arr. 4	Arr. 8		Arr. 4	Arr. 8	Arr. 4	Arr. 8	Arr. 4	Arr. 8		
14-18	03	05	143T-145T	17¾	19½	18	38	182TC-184TC	20%	3%	12 ¹⁵ / ₁₆	31 ⁵ / ₁₆	21 ³ / ₁₆	8 ⁵ / ₈	15	8 ⁷ / ₈	9 ¹ / ₈	9 ³ / ₄	10			
			182T-184T	19		23½	40%					17 ¹³ / ₁₆		32 ¹³ / ₁₆	14½					16½		
	04	06	143T-145T	17¾		19	39	182TC-184TC	21%		13 ⁷ / ₁₆	31 ¹³ / ₁₆	35 ¹ / ₁₆	8 ⁵ / ₈	15							
			182T-184T	19		24½	41%				18 ⁵ / ₁₆	33 ⁵ / ₁₆		14½	16½							
	06	08	143T-145T	17¾		21¾	41%	182TC-184TC	24¼		14%	33	4½	8 ⁵ / ₈	15							
			182T-184T	19		26%	44				20%	34½		14½	16½							
		213T-215T	19¾	46%	213TC-215TC	25½	27%	36¾	36¾	18¾												
15-18	08	08	182T-184T	19	19½	26%	44	182TC-184TC	24¼	3%	20%	34½	4½	14½	16½	8 ⁷ / ₈	9 ¹ / ₈	9 ³ / ₄	10			
			213T-215T	19¾			46%	213TC-215TC	25½			27%		36¾	36¾					18¾		
19-22	03	05	143T-145T	23	23¾	24	38½	182TC-184TC	20%	3%	18 ⁷ / ₁₆	31 ⁵ / ₁₆	21 ³ / ₁₆	15	14½	10 ⁷ / ₈	10 ⁷ / ₈	11 ³ / ₄	11 ³ / ₄			
			182T-184T	24			41%					32 ¹³ / ₁₆		16½								
			213T-215T	24¾			43¾					213TC-215TC		22½						27%	35 ¹ / ₁₆	18¾
	04	06	143T-145T	23		25	39½	182TC-184TC	22%	3%	18 ¹⁵ / ₁₆	31 ¹³ / ₁₆	35 ¹ / ₁₆	15	14½							
			182T-184T	24			42%					33 ⁵ / ₁₆		16½								
			213T-215T	24¾			44¾					213TC-215TC		23½						27%	35 ⁹ / ₁₆	18¾
	06	06	143T-145T	23		25	39½	182TC-184TC	22%	3%	18 ¹⁵ / ₁₆	31 ¹³ / ₁₆	35 ¹ / ₁₆	15	14½							
			182T-184T	24			42%					33 ⁵ / ₁₆		16½								
			213T-215T	24¾			44¾					213TC-215TC		23½						27%	35 ⁹ / ₁₆	18¾
	08	08	182T-184T	24		26%	44	182TC-184TC	24¼	3%	20%	34½	4½	14½	16½							
			213T-215T	24¾			46%	213TC-215TC	25½			27%		36¾	36¾					18¾		
			254T-256T	26			32¼	51%	254TC-256TC			26%		27%	42%					42%	19½	24½
	10	10	213T-215T	24¾		26%	46%	213TC-215TC	25½	2%	20%	36¾	4½	14½	18¾							
			254T-256T	26			32¼	51%	254TC-256TC			26%		27%	42%					42%	19½	24½
			284TS-286TS	26¾			32¼	53%	284TCS-286TCS			33%		27%	42%					42%	19½	24½
	12	12	254T-256T	26		33¼	52%	254TS-256TS	27%	2%	26	42%	5	19½	24½							
			284TS-286TS	26¾			54%	284TSC-286TSC	34%			43%		43%	24½							
			324TS-326TS	29¼			37¼	57%	324TSC-326TSC			36%		30	46%					46%	23½	27½
23-26	03	05	182T-184T	24	26%	25½	42¾	182TC-184TC	22½	3%	18 ¹³ / ₁₆	33 ¹¹ / ₁₆	39 ¹ / ₁₆	14½	17	10 ⁷ / ₈	10 ⁷ / ₈	11 ³ / ₄	11 ³ / ₄			
			213T-215T	24¾			45%	213TC-215TC	N/A			35 ¹⁵ / ₁₆		19¼								
			254T-256T	26			30½	50%	254TC-256TC			N/A		41 ⁵ / ₁₆	24½							
	04	06	182T-184T	24		26½	44%	182TC-184TC	23%	3%	19½	34%	3%	14½	17							
			213T-215T	24¾			46¾	213TC-215TC	N/A			36%		19¼								
			254T-256T	26			31 ⁷ / ₈	51½	254TC-256TC			N/A		42	24½							
	06	08	182T-184T	24		26½	44%	182TC-184TC	23%	3%	19½	34%	3%	14½	17							
			213T-215T	24¾			46¾	213TC-215TC	25½			36%		19¼								
			254T-256T	26			31 ⁷ / ₈	51½	254TC-256TC			26¼		42	24½							
	08	08	182T-184T	24		26½	46¾	213TC-215TC	25½	3¼	19½	36%	3%	14½	19¼							
			254T-256T	26			31 ⁷ / ₈	51½	254TC-256TC			26¼		42	24½							
			284TS-286TS	26¾			53½	284TS-286TS	33			42¾		42¾	19½					25¾		
10	10	254T-256T	26	33¼	52%	254TC-256TC	27%	3¼	26	43%	5	19½	24½									
		284TS-286TS	26¾		54%	284TCS-286TCS	34%			43%		43%	19½	25¾								
		324TS-326TS	29¼		37¼	58%	324TCS-326TCS			36%		30	46%	46%	23½	27½						
12	12	284TS-286TS	28¼	37¼	54%	284TCS-286TCS	34%	3¼	30	43%	5	23½	25¾									
		324TS-326TS	29¼		58%	324TCS-326TCS	36%			43%		43%	23½	27½								

N/A = Not Available

Tolerance: ± 1/8"

* Dimensions may vary slightly depending on motor manufacturer. Given "H" dimensions were based on the larger of those motors most frequently used by **nyb**. † On fan Sizes 23-26 with Size 12 outlet and Bottom Horizontal discharge, the flange extends 1/2" below the floorline.

The New York Blower Company has a policy of continuous product development and reserves the right to change designs and specifications without notice.

ARRANGEMENTS 1, 9, 10

Dimensions not to be used for construction unless certified. Note: See page 12 for dimensional drawings.

ARRANGEMENTS 1, 9, & 10 DIMENSIONS [INCHES]

Wheel dia.	Outlet Size	Inlet flange	A†		H		K		N		R		S		T		U		V
			Arr. 1	Arr. 10	Arr. 1	Arr. 10	Arr. 1/9	Arr. 10	Arr. 1	Arr. 10	Arr. 1/9	Arr. 10	Arr. 1	Arr. 10	Arr. 1/9	Arr. 10	Arr. 1/9	Arr. 10	Arr. 1/9
14-18	03	05	19½	21	24⅝	30⅛	3	3½	15⅛	22	21⅜	37/8	12¼	17¾	9⅛	9¾	10	10¼	8¼
	04	06			25⅝	31⅛					35/16	4¾							
	06	08			28	33½					4½	5½							
15-18	08	08	23⅝	27⅝	26⅛	35⅛	4	4½	15⅛	26	21⅜	4⅝	12¼	197/8	107/8	12¼	11¾	13	11
	03	05			27⅛	36⅛					35/16	5⅛							
	04	06			29	38					4½	6¼							
	06	06			29	38					5	6¾							
	08	08			30	39					5	6¾							
19-22	03	05	26⅝	277/8	28¼	36¼	5	4½	15⅛	26	33/16	4¼	12¼	197/8	107/8	12¼	11¾	13	11
	04	06			29⅝	37⅝					37/8	5⅝							
	06	08			29⅝	37⅝					5	6¾							
	08	08			31	39					5	6¾							
	10	10			31	39					5	6¾							

† On fan sizes 12, outlet and Bottom Horizontal discharge, the flange extends ½" below the floorline.

Tolerance: ± 1/8"

ARRANGEMENT 9 DIMENSIONS [INCHES]

Fan Size	Outlet Size	Pedestal Number	H	Fan Size	Outlet Size	Pedestal Number	H	Fan Size	Pedestal Number	Max. C-NW	Max. Frame Size	A	N	S			
14-18	03	1	24⅝	19-22	08,10	5	29	23-26	14-18	1	135/8	256T	19½	15⅛	12¼		
		2	28¾			6	32¾			2	17¾			187/8	16		
		3	32⅛			7	36½			3	21⅛			22⅝	19¾		
		4	35¼			8	39⅝			4	24¼			284T	23½	25¾	227/8
	04	1	25⅝			12	5		30	19-22	326T	23⅝	5	135/8	15⅛	12¼	
		2	29¾				6		33¾				6	17¾	187/8	16	
		3	33⅛				7		37½				7	21⅛	22⅝	19¾	
		4	36¼				8		40⅝				8	24¼	25¾	227/8	
	19-22	06,08	1		28	03	9		42⅝	10	10	35¾	326T	26⅝	26⅝	22⅝	19¾
			2		31¾		10		37½		11	387/8				25¾	227/8
			3		35½		11		40⅛		12	407/8				27¾	247/8
			4		38⅝		12		42¼		13	427/8				27¾	247/8
03		5	26⅛	04,06,08	10	37½	23-26	326T	26⅝	10	21⅛	22⅝	19¾				
		6	297/8		11	40¼				11	24¼	25¾	227/8				
		7	33⅝		12	42¼				12	26¼	27¾	247/8				
		8	36¾		13	44¼				13	28¼	365T	30⅝	29¾	267/8		
04,06	5	27⅛	10,12	10	38½	19-22	326T	26⅝	11	41⅝	22⅝	19¾					
	6	307/8		11	41⅝				12	43⅝	27¾	247/8					
	7	34⅝		12	43⅝				13	45⅝	29¾	267/8					
	8	37¾		13	45⅝												
	9	39¾															

Tolerance: ± 1/8"

FAN DISCHARGES – VIEWED FROM DRIVE SIDE

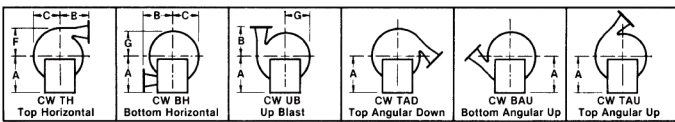

Clockwise—angular discharges at 45°

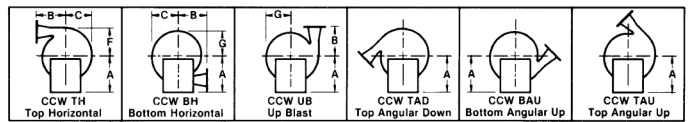

Counterclockwise—angular discharges at 45°

Housings are reversible and rotatable in 22½° increments except Down Blast and Bottom Angular Down which require special construction. Arrangement 10 fans Sizes 19-22 are not rotatable in the field.

The New York Blower Company has a policy of continuous product development and reserves the right to change designs and specifications without notice.

COMPLETE SELECTION OF AIR-MOVING EQUIPMENT

The New York Blower Company offers thousands of different types, models, and sizes of air-moving equipment. Contact your nyb representative for assistance in identifying the best fan for your application.

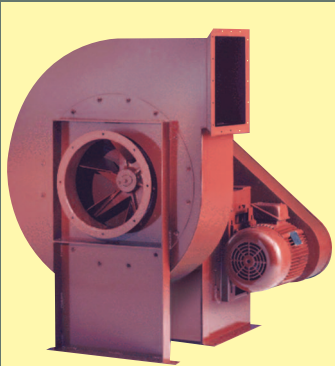

DUST/MATERIAL HANDLING

Wide range of duty available with unique fan lines capable of handling light dust to heavy material. Typical applications include dust-collection and high-pressure process along with material-conveying.

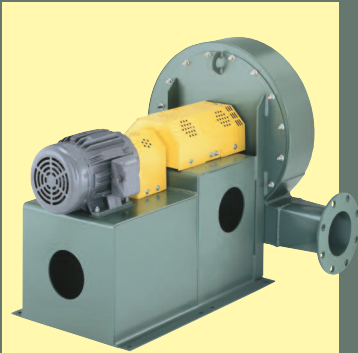

AIR-HANDLING [CENTRIFUGAL]

Designed for clean to moderately dirty gas streams. Commercial and industrial HVAC, process cooling, light material-conveying, heat removal, and dryer exhaust are just a few of the numerous sample applications

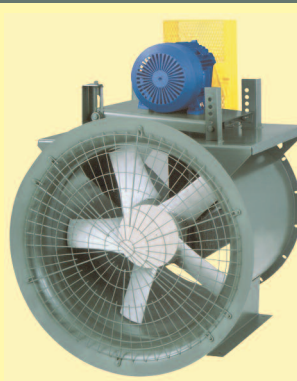

AIR-HANDLING [AXIAL]

For the ideal handling of clean to moderately dirty airstreams. Commercial and industrial HVAC, drying and cooling systems, fume extraction, and process-heat removal are typical applications.



FIBERGLASS REINFORCED PLASTIC [FRP]

Choice of performance and duty for corrosive gas streams. Applications include chemical process, wastewater treatment, laboratory hood exhaust, and tank aeration.

CUSTOM PRODUCTS

Designed for unique applications. Variety of configurations, temperatures, flows, and pressures. Wide range of modifications and accessories are available to meet the most demanding specifications.

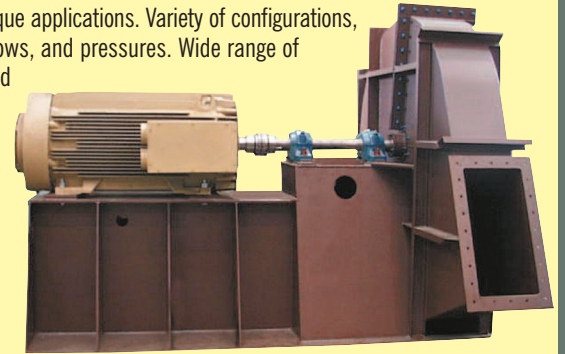

Leading the industry forward since 1889



ROOF VENTILATORS

Including both hooded and upblast ventilators, propeller fans, and centrifugal roof exhausters. These units are ideal for industrial, commercial, and institutional applications.



HEATING PRODUCTS

Industrial-duty steam unit heaters with steam heating coils are available for facility heating and process-heat transfer.

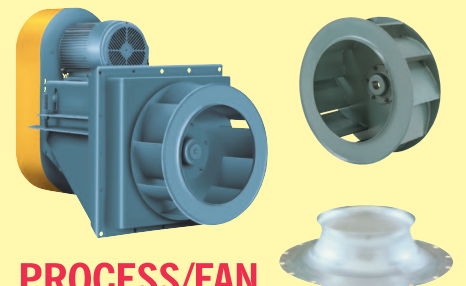

PROCESS/FAN COMPONENTS

Plug fans, plenum fans, wheels, inlet cones, and housings for a wide variety of OEM applications. Process/fan components are used in air-handling units, ovens, dryers, freezer tunnels, and filtration systems.